

HR

# Perilica posuđa Upute za uporabu

PRVI DIO: Generička verzija

PP55TBMD6

# KONČAR

Pažljivo pročitajte ovaj priručnik prije upotrebe perilice posuđa i sačuvajte ga za buduću upotrebu.

# SADRŽAJ

01	3	<b>SIGURNOSNE INFORMACIJE</b>
02	8	<b>PREGLED PROIZVODA</b>
03	9	<b>UPORABA PERILICE POSUĐA</b>
	9	Dodavanje soli u omekšivač
04	11	<b>ODRŽAVANJE I ČIŠĆENJE</b>
	11	Održavanje vanjskih površina
	11	Održavanje unutrašnjosti
	13	Održavanje perilice posuđa
05	15	<b>UPUTE ZA UGRADNJU</b>
	15	O priključku napajanja
	16	Dovod i odvod vode
	17	Spajanje odvodnih crijeva
	18	Postavljanje uređaja
06	19	<b>U SLUČAJU PROBLEMA</b>
07	22	<b>PUNJENJE KOŠARA</b>



## **NAPOMENA:**

- Pročitajte poglavlje o uklanjanju problema kako biste neke od njih mogli riješiti sami.
- Ako problem ne možete otkloniti sami, molimo da zatražite pomoć od stručne osobe.
- U skladu s politikom stalnog razvoja i ažuriranja, proizvođač zadržava pravo na izmjene proizvoda bez najave.
- Izgubite li ovaj priručnik ili je zastario, možete zatražiti novi od proizvođača ili odgovarajućeg prodavatelja.

# SIGURNOSNE INFORMACIJE

## **⚠ UPOZORENJE**

**Prilikom uporabe perilice, pridr avajte se mjera opreza u nastavku:**

- Ugradnju i popravak smije izvesti samo kvalificirani tehničar
- Ovaj uređaj namijenjen je za uporabu u kućanstvu i slične primjene kao npr.:
  - u kuhinjama za osoblje u prodavaonicama, uredima i drugim radnim mjestima;
  - na seoskim gospodarstvima;
  - za korištenje gostima u hotelima, motelima i drugim oblicima smještaja;
  - u pansionima.
- Ovaj uređaj ne smiju upotrebljavati djeca mlađa od 8 godina te osobe smanjenih fizičkih, osjetilnih i mentalnih sposobnosti, kao ni osobe s nedostatkom potrebnog znanja i iskustva, bez nadzora ili pomoći osobe odgovorne za njihovu sigurnost. Odgovorna osoba ih treba uputiti u sigurno rukovanje uređajem i pobrinuti se da razumiju opasnosti povezane s rukovanjem.
- Nemojte dozvoliti djeci da se igraju s uređajem. Djeca smiju uređaj čistiti i održavati samo uz nadzor. (Za EN60335-1)
- Ovaj uređaj ne smiju koristiti osobe (uključujući djecu) sa smanjenim fizičkim, osjetilnim ili mentalnim

sposobnostima kao ni osobe bez adekvatnog iskustva i znanja, osim pod nadzorom osobe odgovorne za njihovu sigurnost ili ako im je takva osoba pružila upute potrebne za uporabu uređaja. (Za IEC60335-1)

- Ambalaža može biti opasna za djecu!
- Ovaj uređaj je namijenjen isključivo za uporabu u kućanstvu, u zatvorenom prostoru.  
Kako biste spriječili opasnost od strujnog udara, nemojte uranjati uređaj, kabel ili utikač u vodu ili drugu tekućinu.
- Prije čišćenja i održavanja odspojite uređaj s napajanja.
- Upotrijebite mekanu krpu navlaženu blagim sredstvom za pranje i prebrišite suhom krpom.

## Upute za uzemljenje

---

- Ovaj uređaj treba biti uzemljen. U slučaju nepravilnosti ili kvara, uzemljenje će smanjiti opasnost od strujnog udara omogućavajući put najmanjeg otpora električne struje. Uređaj je opremljen utikačem s vodom za uzemljenje.
- Utikač se mora priključiti u odgovarajuću utičnicu koja je ugrađena i uzemljena u skladu sa svim lokalnim zakonima i propisima.
- Nepravilno povezivanje vodiča uzemljenja opreme može dovesti do opasnosti od strujnog udara.
- Ako niste sigurni je li uređaj pravilno uzemljen, provjerite s kvalificiranim električarom ili serviserom.

- Ako utikač koji ste dobili s proizvodom ne odgovara utičnici, nemojte ga zamijeniti.
- Kvalificirani električar mora ugraditi odgovarajuću utičnicu.
- Nemojte sjediti ili stajati na vratima ili rešetki za posuđe, ili grubo rukovati njima.
- Nemojte koristiti perilicu ako nije dokraja sastavljena i zatvorena.
- Pažljivo otvarajte vrata dok perilica radi jer postoji opasnost od prskanja vode.
- Nemojte stajati na vratima niti na njih odlagati teške predmete kad su otvorena. Uređaj bi se mogao prevrnuti.
- Prilikom punjenja perilice:
  - 1) Postavite oštre predmete tako da ne oštete brtvu vrata;
  - 2) Upozorenje: Noževi i ostali oštri kuhinjski pribor mora se staviti u košaru za pribor za jelo oštricom okrenutom nadolje, ili postaviti vodoravno u gornju košaru.
- Neki deterdženti su izrazito alkalni. Mogu biti iznimno opasna ukoliko ih se proguta. Izbjegavajte kontakt s kožom i očima i držite djecu dalje od perilice kad su vrata otvorena.
- Provjerite je li pretinac sredstva za pranje posuđa prazan nakon završetka ciklusa pranja.

- Nemojte prati plastične predmete osim ako nemaju oznaku da ih je sigurno prati u perilici.
- Za neoznačene plastične predmete provjerite upute proizvođača.
- Koristite samo sredstva za pranje i ispiranje namijenjena za perilice posuđa.
- Nikad ne koristite sapun, deterdžent za rublje ili ručno pranje posuđa.
- Ne ostavljajte vrata uređaja otvorenima – opasnost od spoticanja.

Ako je kabel napajanja oštećen, zamijeniti ga smije samo proizvođač, njegov servisni agent ili osoba sa sličnim kvalifikacijama, kako bi se umanjio rizik od opasnosti.

- Tijekom postavljanja pazite da ne prignječite ili prekomjerno ne svijate kabel napajanja.
- Nemojte preinačavati kontrole.
- Uređaj se na glavni dovod vode mora spojiti pomoću novog crijeva. Ne upotrebljavajte rabljena crijeva.
- Kako bi trošio manje električne energije, uređaj će se u pripravnom stanju automatski isključiti ako tijekom 15 minuta ne pokrenete nijednu funkciju.

Maksimalan broj kompleta posuđa koje možete prati je 6.

Maksimalni dozvoljeni pritisak dovoda vode iznosi 1 MPa.

Minimalan dozvoljeni pritisak dovoda vode iznosi 0,04 MPa.

## Zbrinjavanje

---

- Ambalažu i dotrajali uređaj zbrinite u reciklažnom centru. Prije toga odrežite kabel napajanja i onesposobite bravu vrata kako se ne bi mogla zatvoriti.
- Kartonski dijelovi načinjeni su od recikliranog papira i treba ih zbrinuti u kontejnere za papir.
- Pravilnim odlaganjem ovog proizvoda pomažete u sprečavanju mogućih štetnih posljedica, do kojih može doći uslijed nepravilnog odlaganja proizvoda.
- Za više informacija o recikliranju ovog proizvoda kontaktirajte odgovarajući ured lokalne samouprave ili službu za zbrinjavanje komunalnog otpada.
- **ZBRINJAVANJE: Nemojte zbrinjavati ovaj uređaj zajedno s nerazvrstanim gradskim otpadom. On spada u otpad koji se prikuplja zasebno.**



# PREGLAD PROIZVODA

## ❗ VAŽNO:

Kako biste maksimalno iskoristili performanse perilice, prije prve uporabe pročitajte sve upute.

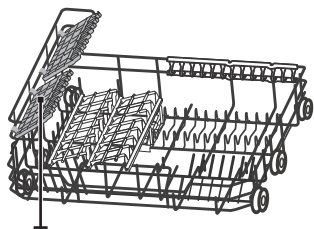
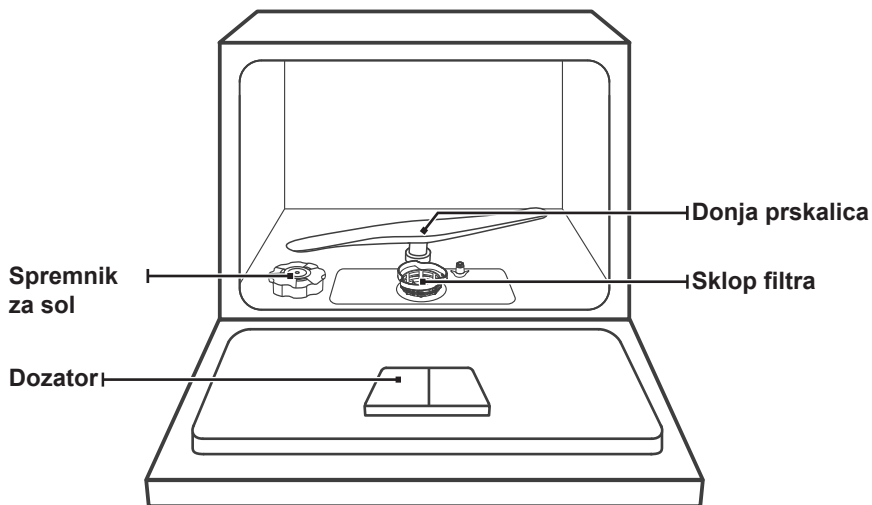

Rešetka za šalice  
Košara

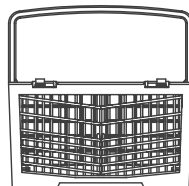

Košara za jedaći pribor

## 💡 NAPOMENA:

Slike su samo za referencu, različiti modeli mogu biti različiti. Pridržavajte se onoga što vrijedi za vaš model.



# UPORABA PERILICE

Prije prve uporabe perilice:



1. Podesite omekšivač vode
2. Dodavanje soli u omekšivač
3. Punjenje košare
4. Punjenje spremnika sredstvom za pranje posuđa



Ako trebate podesiti omekšivač vode, provjerite odjeljak "Omekšivač vode" u prvome poglavlju drugoga dijela: Posebna verzija.

## Dodavanje soli u omekšivač

### NAPOMENA:

Ako vaš model nema omekšivač vode, možete preskočiti ovaj dio.

Uvijek upotrebljavajte sol namijenjenu perilicama posuđa.

Spremnik za sol nalazi se ispod košare, a treba ga napuniti prema uputama u nastavku.

### UPOZORENJE

- **Upotrebljavajte isključivo sol namijenjenu perilicama posuđa!**  
Bilo koja druga sol koja nije izričito namijenjena uporabi u perilicama, pogotovo kuhinjska sol, može oštetiti omekšivač vode. Proizvođač se odriče odgovornosti i ne daje nikakva jamstva u slučaju šteta nastalih uslijed korištenja neprikladne soli.
- **Sol dodajte samo prije pokretanja programa pranja.**  
To će onemogućiti da na dnu perilice ostanu zrna soli ili slana voda, što može uzrokovati koroziju.

Za dodavanje soli u perilicu slijedite navedene korake:

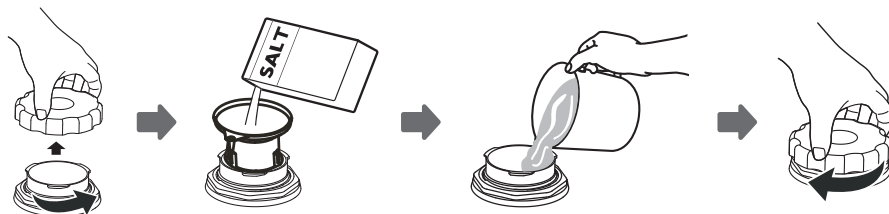

1. Izvadite košaru i odvijte čep spremnika.
2. Stavite kraj (isporučeni) lijevka u otvor i uspite oko 1 kg soli.
3. Prije prvog pranja, napunite spremnik vodom do oznake maksimuma. Normalno je da iz spremnika za sol iscure malo vode.
4. Nakon punjenja spremnika čvrsto zatvorite čep.
5. Indikator upozorenja na sol će se isključiti nakon što spremnik napunite solju.
6. Pokrenite program pranja odmah nakon punjenja spremnika solju (savjetujemo da taj program bude kratak). U suprotnom bi se sustav filtriranja, pumpa ili drugi važni dijelovi perilice mogli oštetiti od slane vode. To nije pokriveno jamstvom.

## **NAPOMENA:**

- Spremnik za sol valja dopuniti samo kad na upravljačkoj ploči zasvijetli indikator upozorenja na sol (  ). Indikator upozorenja može ostati svijetliti i nakon dodavanja soli, ovisno o tome koliko se brzo otapa. Ako na kontrolnoj ploči nema indikatora za manjak soli (kod nekih modela), možete sami procijeniti kad treba dodati sol prema broju ciklusa perilice.
- Ako se sol prospe, pokrenite kratki ili program namakanja kako biste je uklonili.

# ODRŽAVANJE I ČIŠĆENJE

## Održavanje vanjskih površina

### Vrata i brtva na vratima

Redovito čistite brtve na vratima mekom vlažnom krpom kako biste uklonili ostatke od hrane.

Prilikom punjenja perilice mogu na bočne strane vrata perilice kapnuti ostaci hrane i pića. Te su površine na vanjskom dijelu kućišta i njima ne može pristupiti voda iz prskalice. Obrišite sve ostatke prije zatvaranja vrata.

### Upravljačka ploča

Ako je potrebno čišćenje, upravljačku ploču obrišite samo mekom vlažnom krpom.

#### UPOZORENJE

- Kako voda ne bi prodrla u bravu na vratima i električne komponente, nemojte koristiti sredstvo za čišćenje u spreju bilo koje vrste.
- Na vanjskim površinama nikada ne upotrebljavajte abrazivna sredstva za čišćenje ili grube spužvice, jer mogu ostrugati završni sloj. I neki papirnati ručnici mogu ogrepsi površinu ili ostaviti tragove na njoj.

## Održavanje unutrašnjosti

### Sustav za filtriranje

Sustav za filtriranje u donjem dijelu perilice zadržava grube nečistoće iz ciklusa pranja. Sakupljeni grubi ostaci mogu uzrokovati začepljenje filtra. Redovito provjeravajte stanje filtera i po potrebi ih očistite pod tekućom vodom. Za čišćenje filtera perilice slijedite dolje navedene korake.

### NAPOMENA:

Slike su samo za referencu, različiti modeli sustava za filtriranje i prskalice mogu biti različiti. Pridržavajte se onoga što vrijedi za vaš model.

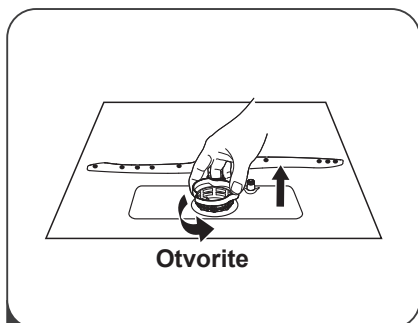

- 1** Držite grubi filter i zakrenite ga u smjeru suprotnom od kretanja kazaljki sata kako biste ga otključali. Podignite filter prema gore i izvadite ga iz perilice posuđa.

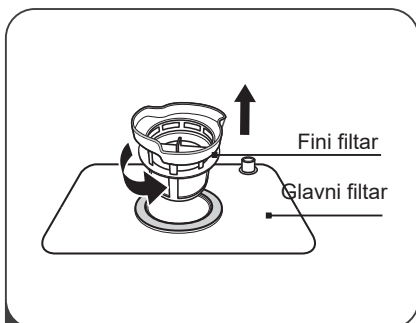

- 2** Podignite fini filter iz glavnog filtra.

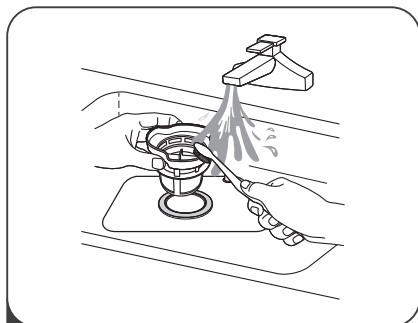

- 3** Veći ostaci hrane mogu se očistiti ispiranjem filtra pod tekućom vodom. Za temeljitije čišćenje upotrijebite meku četku.

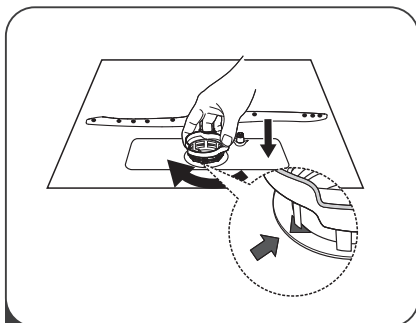

- 4** Ponovno sastavite filtre obrnutim redoslijedom u odnosu na rastavljanje, vratite filtarski sklop na mjesto i zakrenite u smjeru kretanja kazaljki sata prema strelici.

### **⚠ UPOZORENJE**

- Filtre nemojte previše zatezati. Dobro učvrstite filtre odgovarajućim redoslijedom, jer u protivnom mogu u sustav ući grube nečistoće i uzrokovati blokadu.
- Perilicu za posuđe NIKADA ne upotrebljavajte bez postavljenih filtara. Nepravilno vraćanje filtra na mjesto može smanjiti učinkovitost uređaja te oštetiti posuđe i pribor.

## Prskalice

Potrebno je redovito čistiti prskalice jer će kemikalije u tvrdoj vodi začepiti njihove mlaznice i ležajeve.

Za čišćenje prskalice slijedite upute u nastavku:

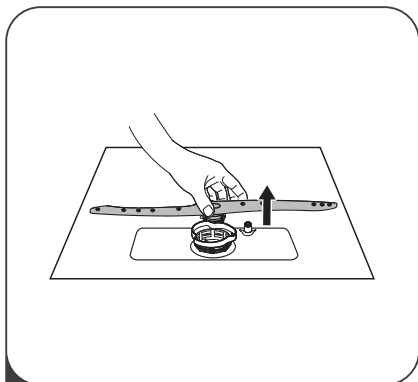

- 1** Za skidanje donje prskalice, izvucite je prema gore.

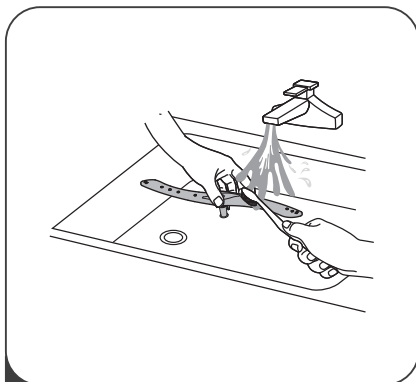

- 2** Operite prskalice u toploj vodi sa sapunicom i očistite mlaznice mekanom četkom. Dobro ih isperite i vratite na mjesto.

## Održavanje perilice posuđa

### Mjere opreza od smrzavanja

Poduzmite potrebne mjere za zaštitu od smrzavanja perilice posuđa zimi.

Nakon svakog ciklusa pranja postupite na sljedeći način:

1. Odspojite perilicu s napajanja.
2. Zatvorite dovod vode i odvojite cijev za dovod vode od ventila vode.
3. Izbacite vodu iz dovodnog crijeva i ventila za vodu. (Sakupite vodu u lonac)
4. Ponovno priključite dovodno crijevo na ventil za vodu.
5. Izvadite filter s dna odjeljka za pranje i spužvom pokupite vodu sakupljenu u sifonu.

### Nakon svakog pranja

Nakon svakog pranja zatvorite dovod vode i ostavite vrata odškrinuta tako da se vlaga i mirisi ne zadrže u unutrašnjosti perilice.

## **Odspajanje utikača**

Prije čišćenja ili održavanja, uvijek izvucite utikač kabela napajanja iz utičnice.

## **Nemojte koristiti otapala ili abrazivna sredstva za čišćenje**

Za čišćenje vanjskih i gumenih dijelova perilice posuđa nemojte koristiti otapala ili abrazivna sredstva za čišćenje. Koristite samo krpu i toplu vodu sa sapunicom. Za uklanjanje mrlja s unutrašnjih površina koristite krpu navlaženu u vodi i malo octa, ili sredstvo za čišćenje izričito namijenjeno perilicama posuđa.

## **U slučaju duljeg nekorištenja**

Preporučuje se da pokrenete ciklus pranja s praznom perilicom posuđa i kad završi izvucite kabel napajanja iz utičnice, zatvorite dovod vode i ostavite vrata perilice odškrinuta. To će produžiti vijek trajanja brtva i spriječiti stvaranje mirisa unutar uređaja.

## **Pomicanje uređaja**

Ako je potrebno pomaknuti uređaj, pokušajte ga držati okomitom položaju. Ako je apsolutno nužno, polegnite ga s poledinom prema dolje.

## **Brtve**

Jedan od uzroka neugodnih mirisa u perilici jest hrana koja je zapela u brtvama. Povremeno čišćenje vlažnom spužvom spriječit će tu pojavu.

# UPUTE ZA UGRADNJU

## ⚠ UPOZORENJE



### Opasnost od strujnog udara

Prije ugradnje perilice isključite je s napajanja.

Ako to ne učinite, izlažete se opasnosti sa smrtnim posljedicama ili strujnom udaru.

## ⚠ Pozor

Spajanje crijeva i spajanje na struju povjerite profesionalcima.

## O priključku napajanja

## ⚠ UPOZORENJE

Radi vaše sigurnosti:

- Uz ovaj uređaj nemojte koristiti produžni kabel ili adapter.
- Ni u kojem slučaju nemojte presijecati ili uklanjati uzemljenje s kabela napajanja.

## Uvjeti za spajanje na električnu mrežu

Pogledajte pločicu s podacima kako biste saznali nazivni napon i priključili perilicu posuđa na odgovarajuće napajanje. Upotrijebite odgovarajući osigurač od 10 A / 13 A / 16 A, osigurač s vremenskom odgodom ili automatski osigurač te osigurajte odvojeni strujni krug samo za ovaj uređaj.

## Električno povezivanje

Napon i frekvencija električne mreže treba odgovarati onome koji je naveden na pločici s podacima. Spojite utikač samo na pravilno uzemljenu utičnicu. Ako električna utičnica za uređaj nije prikladna za utikač, zamijenite je umjesto da koristite adaptere ili slično jer mogu prouzročiti pregrijavanja i opekline.

⚠ Prije uporabe osigurajte pravilno uzemljenje

# Dovod i odvod vode

## Spajanje na dovod vode

Spojite crijevo za dovod hladne vode na priključni navoj od 3/4 inča i vodite računa da je spoj čvrst.

Ako su crijeva za vodu nova ili nisu korištena dulje vrijeme, pustite da voda teče kako biste se uvjerali da je voda bistra. Ova je mjera opreza potrebna kako bi se izbjegao rizik od blokiranja ulaza vode i oštećenja uređaja.

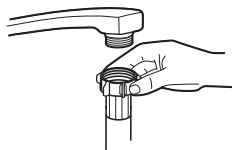

Obično dovodno crijevo



Sigurnosno dovodno crijevo

## O sigurnosnom dovodnom crijevu

Sigurnosno dovodno crijevo ima dvostruke stjenke. Sustav crijeva služi prekidu dovoda vode u slučaju pucanja crijeva i kad je prostor između samog dovodnog crijeva i vanjskog valovitog crijeva pun vode.

### **▲ UPOZORENJE**

Crijevo na slavini sudopera može prsnuti ako je spojeno na isti dovod vode kao i perilica. Ako vaš sudoper ima takvo crijevo, preporuča se da ga skinete i začepite odvod.

## Spajanje sigurnosnog dovodnog crijeva

1. Izvadite sigurnosno dovodno crijevo iz spremnika na poleđini perilice.
2. Zategnite vijke dovodnog crijeva na slavinu navoja od 3/4 inča.
3. Prije pokretanja perilice otvorite vodu dokraja.

## Odspajanje sigurnosnog dovodnog crijeva

1. Zatvorite vodu.
2. Odspojite sigurnosno dovodno crijevo sa slavine.



# Spajanje odvodnih crijeva

Stavite odvodno crijevo u odvod minimalnog promjera od 4 cm, ili pustite da voda otječe u sudoper, pazeći da se crijevo ne savija ili gnječi. Odvodno crijevo mora biti postavljeno na visinu manju od 600 mm. Kako biste spriječili povratni tok, slobodni kraj crijeva ne smije biti uronjen u vodu.

⚠ Učvrstite odvodno crijevo u položaj A ili B.

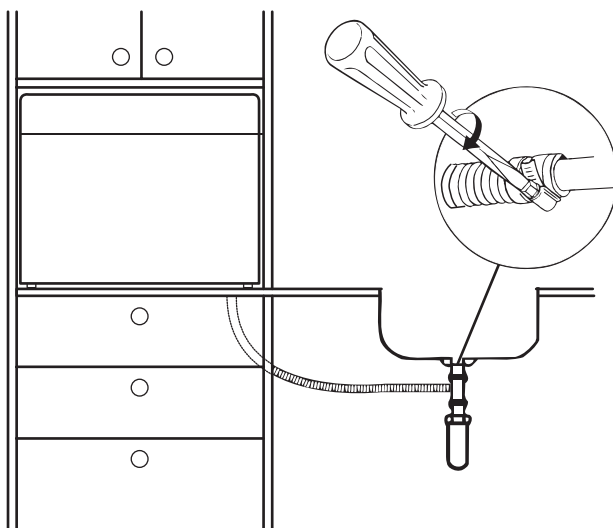
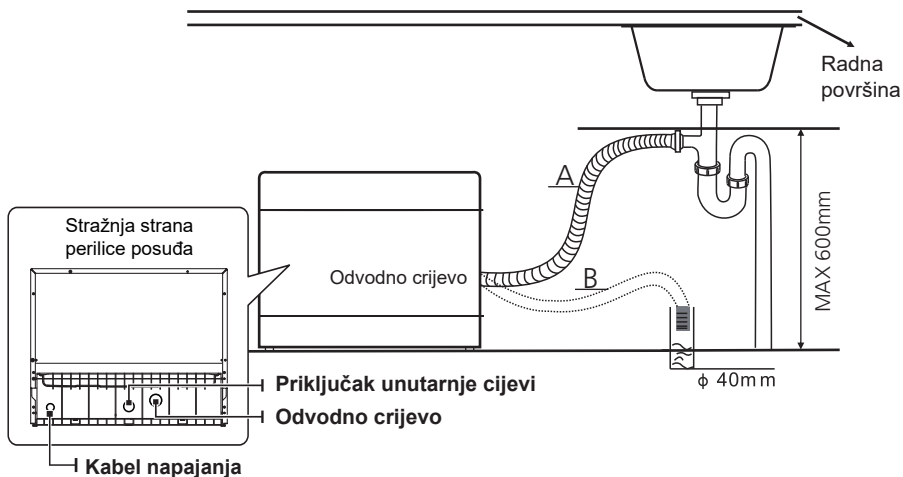

## **Kako isprazniti višak vode iz crijeva**

Ako je sudoper više od 1000 mm od poda, višak vode u crijevima ne može se neposredno izljevati u sudoper. Višak vode iz crijeva nužno je ispustiti u zdjelu ili sličnu posudu, nižu od sudopera.

## **Izlaz vode**

Spojite odvodno crijevo. Odvodno crijevo mora biti pravilno pričvršćeno kako bi se izbjeglo curenje vode. Pazite da crijevo za odvod vode ne bude savijeno ili prignječeno.

## **Produžno crijevo**

Ako vam je potreban produžetak odvodnog crijeva, upotrijebite slično odvodno crijevo. Ne smije biti duže od 4 metra; u suprotnom će perilica biti manje efikasna.

## **Spajanje na sifon**

Priključak odvodne vode mora biti na visini manjoj od 100 cm (maks.) od dna posude. Odvodno crijevo morate učvrstiti.

## **• Postavljanje uređaja**

---

Postavite uređaj na željeno mjesto. Poledina uređaja mora biti naslonjena na zid iza njega, a bočne stranice uz susjedne elemente li zidove. Perilica je opremljena dovodnim i odvodnim crijevima koja se mogu postaviti na desnu ili lijevu stranu.

# U SLUČAJU PROBLEMA

## Prije pozivanja servisa

Pogledajte tablice na sljedećim stranicama, jer možda sadrže rješenje problema bez pozivanja servisa.

Problem	Mogući uzrok	Rješenje
Perilica se ne uključuje	Osigurač je pregorio ili iskočio.	Zamijenite osigurač ili ga vratite na mjesto. Odspojite sve uređaje spojene na isti strujni krug kao i perilica.
	Napajanje nije uključeno.	Provjerite je li perilica posuđa uključena i jesu li vrata dobro zatvorena. Provjerite je li kabel napajanja pravilno spojen na zidnu utičnicu.
	Vrata nisu pravilno zatvorena.	Pravilno zaprite vrata, tako da se zapahnejo.
Voda ne istječe iz perilice	Odvodno crijevo je oštro savijeno	Provjerite odvodno crijevo.
	Filtar je začepjen.	Provjerite grubi filtari. (pogledajte odjeljak "Održavanje unutrašnjosti")
	Kuhinjski sudoper je začepjen.	Provjerite može li voda slobodno otjecati kroz odvod. Ako je problem u začepjenom kuhinjskom sudoperu, možda će vam trebati vodoinstalater, a ne serviser za perlice.
Pjena u unutrašnjosti	Neodgovarajući deterđent	Koristite poseban deterđent za strojno pranje posuđa kako se ne bi stvarala pjena. Ako se to dogodi, otvorite perilicu posuđa i pustite da pjena ispari. Na dno perilice posuđa dodajte 1 litru hladne vode. Zatvorite i zaključajte perilicu posuđa, zatim pokrenite bilo koji ciklus pranja kako bi se izbacila voda. Po potrebi ponovite.
	Proliveno sredstvo za ispiranje.	Prolivena sredstva za ispiranje uvijek odmah obrišite.
Zamrljana unutrašnjost perilice	Koristili ste deterđent s bojilima.	Odaberite deterđent bez bojila.
Bijele naslage u unutrašnjost perilice	Minerali tvrde vode	Očistite unutrašnjost perilice vlažnom spužvom i sredstvom za pranje posuđa. Nikad ne koristite nijedno drugo sredstvo osim ono za strojno pranje posuđa kako se ne bi stvarala prekomjerna pjena.

<b>Problem</b>	<b>Mogući uzroci</b>	<b>Rješenje</b>
Na jedaćem priboru su zamjetne mrlje od hrđe	Taj pribor nije otporan na koroziju.	Izbjegavajte u perilici prati predmete koji nisu otporni na koroziju.
	Niste pokrenuli program nakon dodavanja soli. U ciklus pranja dospjeli su tragovi soli.	Nakon dodavanja soli uvijek pokrenite kratki program pranja s praznom perilicom, bez odabira funkcije Turbo (ako je vaš model ima).
	Labavi poklopac odjeljka za omekšivač	Provjerite poklopac. Mora biti čvrsto zatvoren.
Lupkanje u unutrašnjosti perilice	Prskalica udara o posuđe u košari.	Prekinite program i razmjestite posuđe koje blokira prskalicu.
Zveckanje u unutrašnjosti perilice	Posuđe nije pričvršćeno.	Prekinite program i razmjestite posuđe.
Kuckanje u cijevima za vodu	Uzrok tome možda je mjesto postavljanja ili poprečni presjek cijevi.	To ne utječe na rad perilice. Ako niste sigurni, obratite se stručnom vodoinstalateru.
Posuđe nije čisto	Posuđe nije pravilno postavljeno.	Pogledajte DRUGI DIO, "Priprema i stavljanje posuđa u perilicu".
	Program nije bio dovoljno snažan.	Odaberite intenzivniji program.
	Nedovoljna količina deterdženta.	Upotrijebite više deterdženta ili ga zamijenite drugim.
	Posuđe ometa okretanje prskalice.	Rasporedite posuđe tako da se prskalica može slobodno okretati.
	Sklop filtera na dnu perilice nije čist ili nije pravilno postavljen. To može prouzročiti blokiranje prskalice.	Očistite i/ili pravilno postavite sklop filtera. Očistite mlaznice prskalice.

<b>Problem</b>	<b>Mogući uzroci</b>	<b>Rješenje</b>
Zamagljene čaše i stakleno posuđe	Kombinacija meke vode i previše deterdženta.	Upotrijebite manje deterdženta ako imate meku vodu i odaberite kraći ciklus za pranje staklenog posuđa i čaša.
Crne ili sive mrlje na posuđu	Tragovi dodira aluminijskog posuđa.	Za uklanjanje tih mrlja koristite blago abrazivno sredstvo za čišćenje.
Deterdžent je ostao u spremnicima	Posuđe blokira poklopce spremnika deterdženta.	Pravilno rasporedite posuđe.
Posuđe se ne suši	Nepravilan raspored posuđa	Napunite perilicu prema uputama.
	Prerano izvađeno posuđe	Nemojte prazniti perilicu odmah nakon pranja. Malo odškrinite vrata tako da para može izići. Perilicu ispraznite samo kad posuđe bude jedva toplo na dodir.
	Odabran je pogrešan program.	Kod kraćih programa temperatura vode je niža. To smanjuje učinak pranja. Odaberite program s dužim vremenom pranja.
	Pribor za jelo s niskokvalitetnom oblogom	Odvod vode teži je s takvim predmetima. Pribori za jelo i posuđe takvog tipa nije prikladno za pranje u perilici

### **⚠ UPOZORENJE**

Samostalno ili neprofesionalno popravljanje može dovesti do ozbiljnih rizika za sigurnost korisnika uređaja i može utjecati na jamstvo.

# PUNJENJE KOŠARA PREMA NORMI EN60436:

## 1.Košara

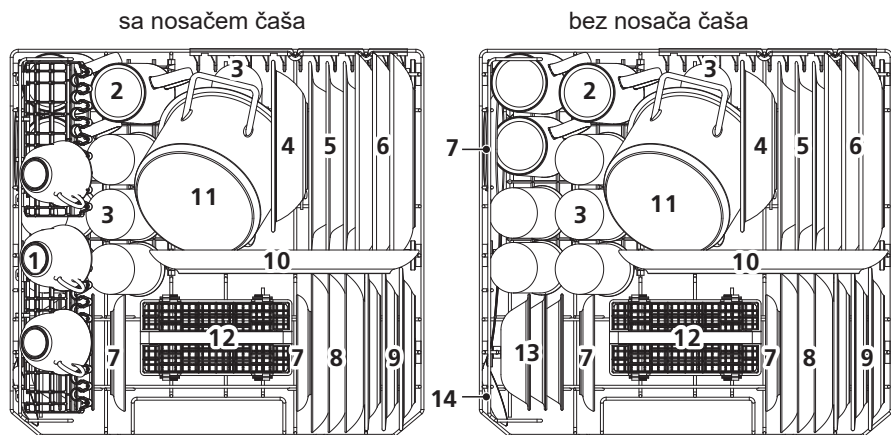

Broj	Predmet
1	Šalice
2	Šalice
3	Čaše
4	Zdjelice od melamina
5	Duboki tanjuri
6	Plitki tanjuri
7	Tanjurići

Broj	Predmet
8	Desertni tanjuri
9	Desertni tanjuri od melamina
10	Ovalni pladanj
11	Mala posuda
12	Košara za jedaći pribor
13	Desertne zdjelice
14	Žlice za posluživanje

## 2. Košara za jedaći pribor:

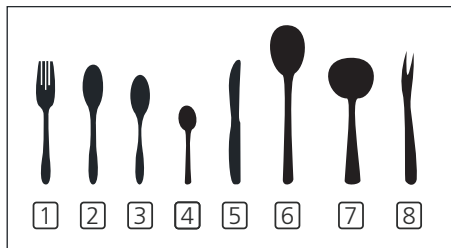
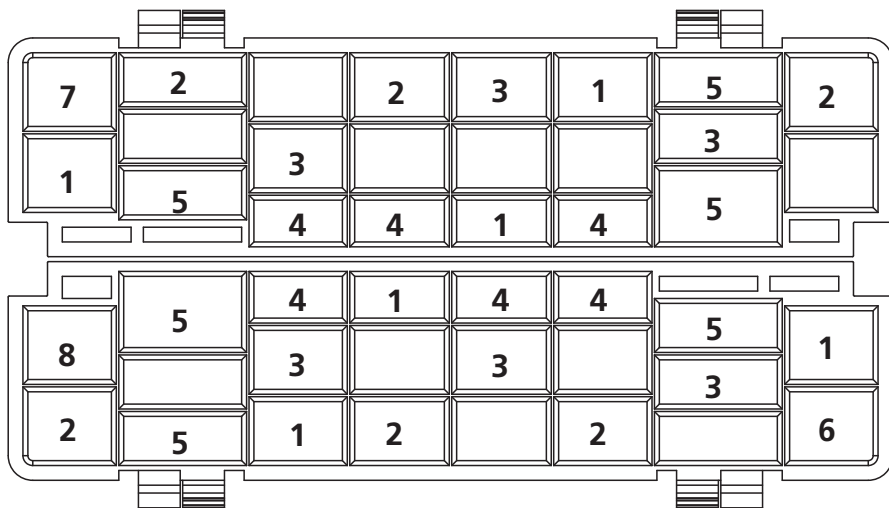

Informacije za testiranje  
kompatibilnosti u skladu sa  
standardom EN 60436:

- Kapacitet: 6 kompleta
- Program: EKO
- Postavka sredstva za ispiranje: Max.
- Postavka omekšivača vode: H4

Broj	Predmet
1	Vilice
2	Žlice
3	Desertne žlice
4	Žličice
5	Noževi
6	Žlice za posluživanje
7	Kutlača
8	Vilice za posluživanje

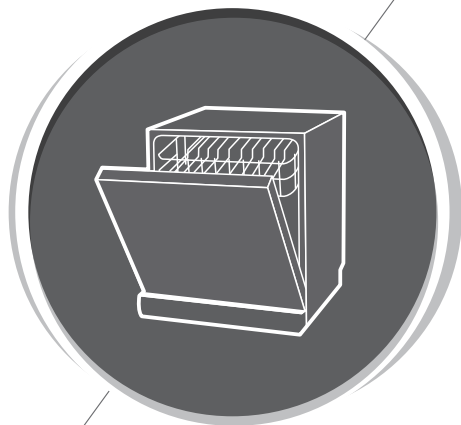

# Perilica posuđa

## Upute za uporabu

**DRUGI DIO: Posebna verzija**

**PP55TBMD6**

**KONČAR**

Pažljivo pročitajte ovaj priručnik  
prije upotrebe perilice posuđa i  
sačuvajte ga za buduću upotrebu.



# SADRŽAJ

01	4	<b>UPORABA PERILICE</b>
	4	Upravljačka ploča
	6	Omekšavanje vode
	7	Priprema i stavljanje posuđa u perilicu
	10	Funkcija sredstva za ispiranje i deterdženta
	11	Punjenje spremnika sredstva za ispiranje
02	12	Punjenje spremnika deterdženta
	13	<b>ODABIR PROGRAMA</b>
	13	Tablica ciklusa pranja
	14	Ušteda energije
	14	Početak programa
03	14	Promjena programa dok je ciklus u tijeku
	15	Zaboravili ste staviti određeno posuđe?
04	16	<b>KODOVI POGREŠAKA</b>
04	17	<b>TEHNIČKI PODACI</b>



## **NAPOMENA:**

- Ako problem ne možete otkloniti sami, molimo da zatražite pomoć od stručne osobe.
- U skladu s politikom stalnog razvoja i ažuriranja, proizvođač zadržava pravo na izmjene proizvoda bez najave.
- Izgubite li ovaj priručnik ili je zastario, možete zatražiti novi od proizvođača ili odgovarajućeg prodavatelja.

# KRATKI VODIČ ZA UPORABU

Detaljne upute za uporabu potražite u odgovarajućim poglavljima ovog priručnika.

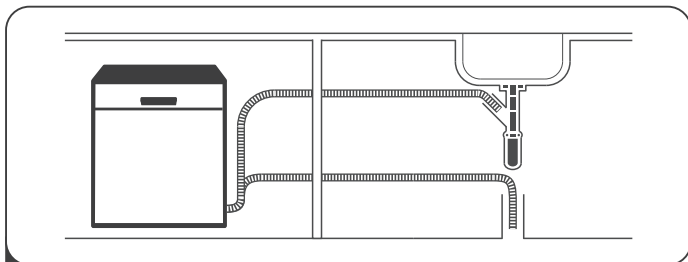

- 1 Ugradnja perilice posuđa  
**(Provjerite odjeljak 5 "UPUTE ZA UGRADNJU" u prvome dijelu: Generička verzija.)**



- 2 Uklonite veće ostatke iz posuđa.  
Nemojte ispirati prije pranja.

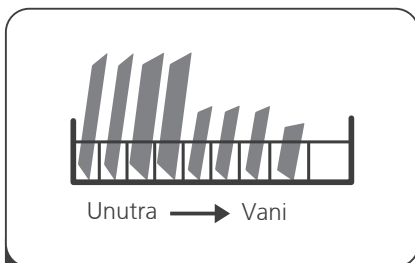

- 3 Napunite košare.

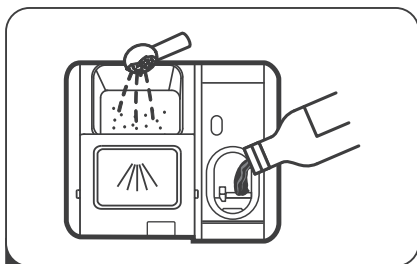

- 4 Napunite dozator deterđžentom i sredstvom za ispiranje.



- 5 Odaberite odgovarajući program i pokrenite perilicu posuđa.

# UPORABA PERILICE

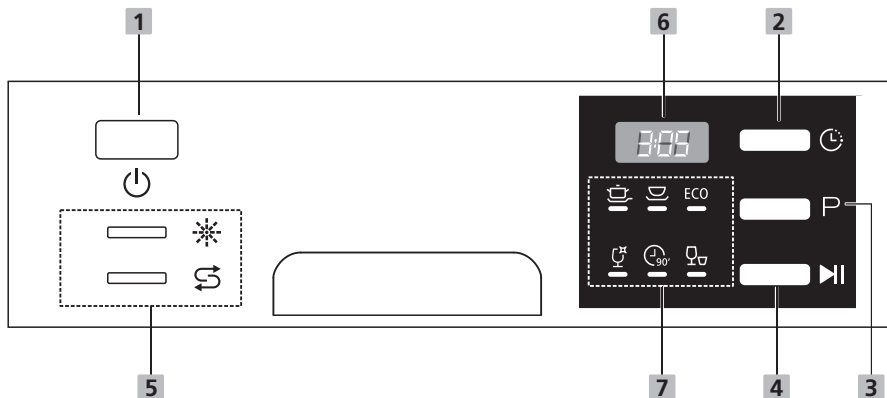

## Upravljačka ploča











### Operation (Button)

<b>1</b> <b>Uključivanje/isključivanje</b>	Pritisnite ovu tipku da biste uključili perilicu.
<b>2</b> <b>Odgoda</b>	Pritisnite ovu tipku za odgodu početka pranja (u satima). Početak pranja možete odgoditi do 24 sata. Jedan pritisak tipke odgađa pranje za 1 sat.
<b>3</b> <b>Program</b>	Pritisnite ovu tipku za odabir odgovarajućeg programa pranja, nakon čega će zasvijetliti odgovarajući indikator.
<b>4</b> <b>Start / Pauza</b>	Za pokretanje odabranog programa pranja ili pauziranje dok perilica posuđa radi.

### Zaslon

<b>5</b> <b>Indikator upozorenja</b>	 <b>Sredstvo za ispiranje</b> Svijetli li indikator “  ”, to znači da nema dovoljno sredstava za ispiranje i da ga treba dodati.
--------------------------------------	---

<p><b>5</b>    <b>Indikator upozorenja</b></p>	<p> <b>Sol</b> Svijetli li indikator "  ", to znači da nema dovoljno soli i da ga treba dodati.</p>
<p><b>6</b>    </p>	<p>Za prikaz vremena rada, vremena odgode, koda pogreške i slično.</p>
<p><b>7</b>    <b>Indikator programa</b></p>	<p> <b>Intenzivno</b> Za jako zaprljano posuđe i normalno zaprljane lonce, tave itd., sa sasušanim ostacima hrane.</p> <p> <b>Univerzalno</b> Za normalno zaprljano posuđe poput lonaca, tanjura, čaša i manje zaprljanih tava.</p> <p><b>ECO ECO</b> Standardni program prikladan za normalno zaprljano posuđe poput lonaca, tanjura, čaša i manje zaprljanih tava. Najučinkovitiji je program u smislu kombinirane potrošnje energije i vode za tu vrstu posuđa.</p> <p> <b>Staklo</b> Za manje zaprljano posuđe i stakleno posuđe.</p> <p> <b>90 min</b> Za manje zaprljano posuđe i staklo.</p> <p> <b>Brzo</b> Kraće pranje za manje zaprljano posuđe koje ne treba sušiti.</p>

# Omekšavanje vode

Omekšivač vode valja podesiti ručno uz pomoć regulatora tvrdoće vode. Omekšivač iz vode uklanja minerale i soli koji mogu štetno utjecati na rad uređaja.

Što voda sadrži više minerala, to je "tvrđa".

Omekšivač valja podesiti u skladu s tvrdoćom vode u vašem području.

Podatak o tvrdoći vaše vode zatražite od lokalne vodoopskrbne tvrtke.

## Podešavanje potrošnje soli

Perilica ima funkciju podešavanja potrošnje soli u skladu s tvrdoćom vode.

Tako se potrošnja soli optimizira i prilagođava.

Molimo da za podešavanje potrošnje soli slijedite donje korake.

1. Zatvorite vrata i uključite uređaj;
2. Pritisnite tipku za program duže od 5 sekundi kako biste pokrenuli modul za podešavanje omekšivača vode u roku od 60 sekundi nakon uključivanja uređaja;
3. Pritisnite tipku program za odabir odgovarajuće postavke u skladu s tvrdoćom vaše vode. Postavke se mijenjaju sljedećim redom:  
H1->H2->H3->H4->H5->H6;
4. Ako pet sekundi ne primijenite nijednu funkciju, izlazi se iz podešavanja i program memorira podešenje.

TVRDOĆA VODE		Podešavanje omekšivača vode	Digitalni prikaz	Regeneracija se odvija svakih X programskih slijedova <sup>3)</sup>
°dH <sup>1)</sup>	Mmol/l <sup>2)</sup>			
0 - 5	0 - 0.9	1	H1	Bez regeneracije
6 - 11	1.0 - 2.0	2	H2	10
12 - 17	2.1 - 3.0	3	H3	5
18 - 22	3.1 - 4.0	4 *	H4	3
23 - 34	4.1 - 6.1	5	H5	2
35 - 45	6.2 - 8.0	6	H6	1

1) Njemački stupanj mjerenja tvrdoće vode

2) milimol, međunarodna jedinica za tvrdoću vode

3) Svaki ciklus s postupkom regeneracije troši dodatne 2,0 litre vode, potrošnju energije povećava za 0,02 kWh, a trajanje programa povećava za 4 minute.

\* tvorničko podešenje



**Ako u perilici posuđa nedostaje soli, provjerite odjeljak "Dodavanje soli u omekšivač" u 3. poglavlju prvoga dijela: Generička verzija.**



## **NAPOMENA:**

**Ako vaš model nema omekšivač vode, možete preskočiti ovaj dio.**

### **Omekšavanje vode**

Tvrdoća vode razlikuje se od mjesta do mjesta. Koristite li s vašom perilicom tvrdu vodu, na posuđu i jedaćem priboru stvaraju se naslage.

Uređaj je opremljen posebnim omekšivačem koji koristi spremnik za sol posebno namijenjen eliminiranju kamenca i minerala iz vode.

## **Priprema i stavljanje posuđa u perilicu**

- Kupujte posuđe i pribor označen kao siguran za perilicu posuđa.
- Za posebne predmete odaberite program sa što nižom mogućom temperaturom.
- Kako biste spriječili oštećenje, nemojte vaditi čaše i pribor za jelo iz perilice posuđa odmah nakon dovršetka programa.

### **Pranje sljedećeg posuđa/pribora za jelo**

#### **Nije prikladno u perilici posuđa:**

- Pribor za jelo s drškama od drva, roga, porculana ili sedefa
- Plastični predmeti neotporni na toplinu
- Stariji lijepljeni pribor za jelo koji nije otporan na toplinu
- Povezani pribor za jelo i posuđe
- Kositreno ili bakreno posuđe
- Kristalno staklo
- Čelični predmeti podložni hrđanju
- Drveni pladnjevi
- Predmeti od sintetičkih vlakana

#### **Djelomično je prikladno:**

- Određene vrste stakla mogu izgubiti sjaj nakon mnogobrojnih pranja
- Srebrni i aluminijski dijelovi skloni su izbljeđivanju tijekom pranja
- Glazirani uzorci mogu izbljedjeti uslijed čestog pranja

## Preporuke za punjenje perilice

Uklonite višak hrane s posuđa i pribora za jelo. Omekšajte ostatke zagorjele hrane u posudama. Nije potrebno isprati posuđe pod mlazom vode.

Za najbolje rezultate rada perilice posuđa pridržavajte se sljedećih smjernica za njezino punjenje.

**(Značajke i izgled košara i košarice za jedaći pribor mogu se razlikovati od vašeg modela.)**

Perilicu posuđa punite na sljedeći način:

- Predmete poput šalica, čaša, lonaca/tava i sl. okrenite prema dolje.
- Zakrivljene predmete, ili one s udubljenjima, potrebno je staviti poprijeko, tako da se s njih može slijevati voda.
- Sav pribor za jelo postavite na siguran način tako da se ne može prevrnuti.
- Sav pribor stavite tako da se prskalice mogu slobodno okretati tijekom pranja.
- Stavite šuplje predmete poput šalica, čaša i lonaca itd. naopako kako se u njima ne bi zadržavala voda.
- Stavite posuđe i pribor za jelo tako da ne leže jedni u drugima ili jedni preko drugih.
- Pazite da se čaše međusobno ne dodiruju kako se ne bi oštetile.
- Gornja košara namijenjena je za osjetljivije i laganije posuđe poput čaša, šalica za kavu i čaj.
- Noževi dugih oštrica postavljeni uspravno predstavljaju moguću opasnost!
- Dugi i/ili oštri komadi pribora za jelo, poput noževa, moraju biti smješteni u vodoravnom položaju u gornju košaru.
- Nemojte prepunjavati perilicu posuđa. To je važno za dobre rezultate i razboritu potrošnju energije.

## NAPOMENA:

Vrlo male predmete ne smijete prati u perilici posuđa jer bi lako mogli ispasti iz košare.

## Vađenje posuđa

Kako voda ne bi kapala s gornje u donju košaru, preporučujemo da prvo ispraznite donju košaru, a tek zatim gornju.

### UPOZORENJE



**Predmeti će biti vrući!** Kako biste spriječili oštećenje, nemojte vaditi čaše i pribor za jelo iz perilice posuđa otprilike 15 minuta nakon dovršetka programa.

## Punjenje košare

Nije moguće sav pribor za jelo postaviti licem prema gore. Za bolje područje čišćenja i učinkovitost pranja preporučujemo da prljavu stranu okrenete prema prskalici. Pazite da posuđe ne viri kroz dno košare kako ne bi blokiralo kretanje prskalice. Maksimalni preporučeni promjer za tanjure ispred dozatora deterdženta je 19 cm, što neće ometati njegovo otvaranje.

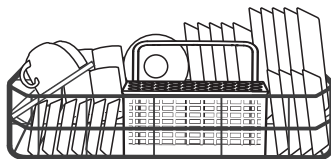

## Punjenje košare za jedaći pribor

Za osobnu sigurnost i vrhunske rezultate pranja, jedaći pribor stavite u košaru pazeći na sljedeće:

- Da se pribor međusobno ne dodiruje.
- Pribor postavite s drškama prema dolje.
- Ipak, noževe i drugi potencijalno opasan pribor stavite s ručkama gore.

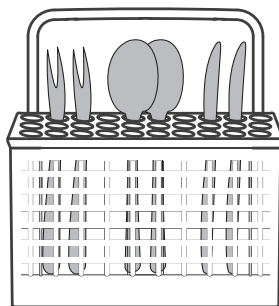

### ⚠ UPOZORENJE



Pazite da jedaći pribor ne proviruje kroz dno košare.  
Oštar pribor uvijek stavite s oštrim vrhom dolje!



Kako biste postigli najbolji učinak pranja, napunite košare na standardni način prema uputama iz zadnjeg poglavlja prvoga dijela:  
Generička verzija



## Funkcija sredstva za ispiranje i deterdženta

Sredstvo za ispiranje ispušta se tijekom završnog ispiranja za sprečavanje mrlja i pruga koje na posuđu mogu ostaviti kapljice vode. Također pomaže pri sušenju jer omogućava slijevanje vode s posuđa. Vaša je perilica namijenjena uporabi s tekućim sredstvima za ispiranje.

### ⚠ UPOZORENJE

Upotrebljavajte samo sredstva za ispiranje poznatih proizvođača. Nikad ne puniti spremnik drugim tekućinama (npr. sredstvima za pranje, deterdžentima). To može oštetiti uređaj.

### Kad napuniti spremnik sredstva za ispiranje

Ako indikator upozorenja na sredstvo za ispiranje (  ) ne svijetli, uvijek možete provjeriti količinu sredstva pomoću optičkog indikatora pokraj čepa. Kad je spremnik sredstva za ispiranje pun, indikator će se posve zatamniti. Tamna se točka smanjuje usporedno s količinom sredstva za ispiranje. Pazite da razina sredstva za ispiranje nikad ne padne ispod 1/4 spremnika.

Kako se količina sredstva za ispiranje smanjuje, smanjuje se i tamna točka kao u nastavku.

Pun     3/4 spremnika     1/2 spremnika     1/4 spremnika     Prazan

### Funkcija deterdženta

Kemijski sastojci deterdženta nužni su za rastvaranje, skidanje i uklanjanje svih nečistoća iz perilice. Za tu je namjenu prikladna većina komercijalnih deterdženata.

### ⚠ UPOZORENJE

- Pravilna uporaba deterdženta  
Koristite samo deterdžent posebno proizveden za perilice posuđa. Deterdžent uvijek mora biti svjež i suh. Deterdžent u prahu nemojte stavljati u spremnik dok posuđe ne bude spremno za pranje.



**Deterdžent za perilice posuđa je korozivan!**

**Deterdžent za perilicu posuđa čuvajte izvan dohvata djece.**

## Punjenje spremnika sredstva za ispiranje

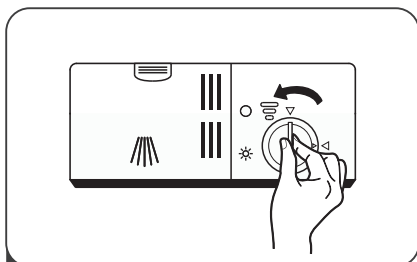

- 1 Za otvaranje spremnika, okrenite čep ulijevo u smjeru strelice i podignite ga.

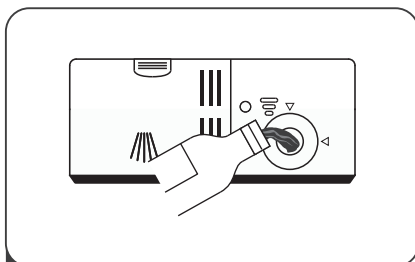

- 2 Pažljivo ulijte sredstvo za ispiranje pazeći da se ne prelije.

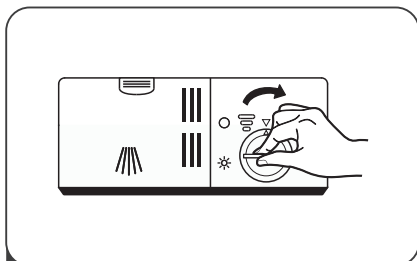

- 3 Vratite čep na mjesto i okrenite ga udesno u smjeru strelice.

### NAPOMENA:

Krpom uklonite višak sredstva za ispiranje koje se proliło tijekom ulijevanja kako biste izbjegli stvaranje prekomjerne pjene kod sljedećeg pranja.

## Podešavanje spremnika sredstva za ispiranje

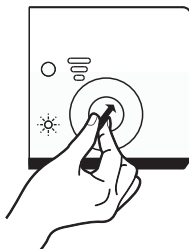

Zakrenite indikator sredstva za ispiranje na broj. Što je broj veći, troši se više sredstva za ispiranje.

Ako se posuđe još uvijek ne suši kako treba ili su zamjetne mrlje, pomaknite regulator na sljedeći veći broj sve dok mrlja ne bude.

Smanjite je ako nakon pranja primijetite bjelkaste mrlje na posuđu ili plavkaste naslage na oštřicama noževa.

## Punjenje spremnika deterdženta



- 1 Pritisnite bravicu na spremniku deterdženta kako biste otvorili poklopac.

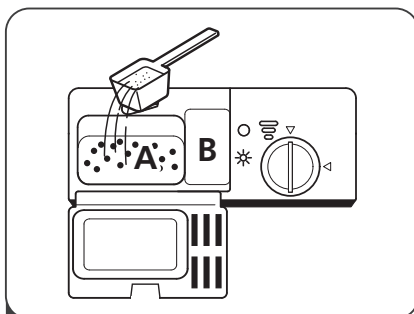

- 2 U veći odjeljak (A) dodajte deterdžent za glavni ciklus pranja. Za pranje jače zaprljanog posuđa dodajte malo deterdženta u manji odjeljak (B) za ciklus pretpranja.

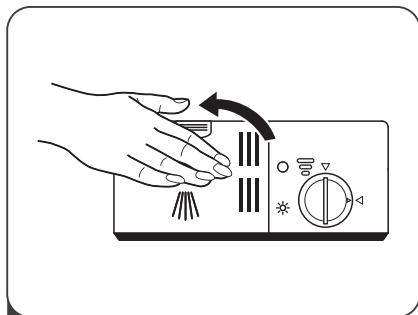

- 3 Zatvorite poklopac i pritisnite ga dok se ne zaključa.



### **NAPOMENA:**





Pridržavajte se preporuka proizvođača na pakiranju deterdženta.

# PROGRAMIRANJE PERILICE POSUĐA

## Tablica ciklusa pranja

Tablica pokazuje koji su programi najbolji za razinu ostataka hrane i koliko deterdženta je potrebno. Također prikazuje razne informacije o programima. Vrijednosti potrošnje i trajanja programa samo su indikativne, osim za program ECO.

(●) označava da program primjenjuje sredstvo za ispiranje u posljednjem ispiranju.

Program	Opis ciklusa	za pretpranje/ glavno pranje	Trajanje (min)	Struja (Kwh)	Voda (L)	za
 <b>Intenzivno</b>	Pretpranje(50)C Pranje(70)C Ispiranje Ispiranje Ispiranje(70)C Sušenje	4/10g <hr/> 1 tableta	140	0.894	9.6	●
	Pretpranje Pranje(60)C Ispiranje Ispiranje(70)C Sušenje	4/10g <hr/> 1 tableta	120	0.667	7.7	●
<b>ECO</b> <small>(* EN60436)</small>	Pretpranje Pranje(45)C Ispiranje(65)C Sušenje	4/10g <hr/> 1 tableta	230	0.613	6.5	●
 <b>Staklo</b>	Pranje(45)C Ispiranje Ispiranje(60)C Sušenje	14g <hr/> 1 tableta	75	0.435	5.8	●
 <b>90 Min</b>	Pranje (65) °C Ispiranje Ispiranje Ispiranje(70)C Sušenje	14g <hr/> 1 tableta	90	0.787	6.6	●
 <b>Brzo</b>	Pranje(40)C Ispiranje Ispiranje	12g <hr/> 1 tableta	30	0.244	5.8	○

### NAPOMENA:

\*En60436 : Program ECO prikladan je za pranje normalno zaprljanog posuđa, jer je za tu upotrebu najučinkovitiji program u pogledu kombinirane potrošnje energije i vode te se upotrebljava za procjenu sukladnosti sa zakonodavstvom EU-a o ekološkom dizajnu.

## Ušteda energije

1. Ručno prethodno ispiranje posuđa dovodi do povećane potrošnje vode i energije i ne preporučuje se.
2. Kad se kućanska perilica posuđa upotrebljava u skladu s uputama za uporabu, pranje posuđa u njoj obično u fazi upotrebe troši manje energije i vode od ručnog pranja.

## Početak programa

1. Izvucite donju i gornju košaru, stavite posuđe i gurnite ih natrag. Preporučujemo da prvo napunite donju košaru, a zatim gornju.
2. Dodajte deterdžent.
3. Spojite utikač u utičnicu. Podaci o napajanju navedeni su u odjeljku "Informacijski list proizvoda". Uvjerite se da je dovod vode otvoren na maksimum, do punog pritiska.
4. Zatvorite vrata pa pritisnite tipku za uključivanje/isključivanje.
5. Odaberite program pa će zasvijetliti odgovarajući indikator. Zatim pritisnite tipku Start/Pauza i perilica će pokrenuti ciklus.

## Promjena programa dok je ciklus u tijeku

Program se može mijenjati samo ako je radio tek kratko vrijeme, inače je deterdžent možda već pušten ili je voda od pranja deterdžentom već ispuštena. U tom slučaju valja perilicu posuđa resetirati i ponovno napuniti spremnik deterdženta. Za resetiranje perilice posuđa slijedite upute u nastavku:

1. Pritisnite tipku Start/Pauza za pauziranje pranja.
2. Pritisnite tipku Program duže od tri sekunde i uređaj će biti u načinu za odabir programa.
3. Pritisnite tipku Program za odabir željenog programa.
4. Pritisnite tipku Start/Pauza, nakon 1 sekunde, perilica posuđa će se pokrenuti.

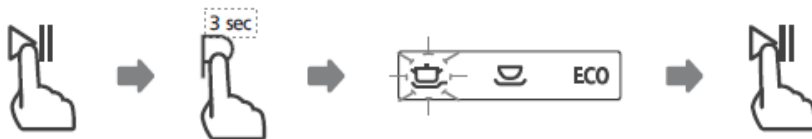

## Zaboravili ste staviti određeno posuđe?

Zaboravljeno posuđe možete dodati u bilo kojem trenutku prije nego što počne ispuštanje deterdženta. U tom slučaju slijedite upute u nastavku:

1. Pritisnite tipku Start/Pauza za pauziranje pranja.
2. Pričekajte 5 sekundi, a zatim otvorite vrata.
3. Dodajte posuđe.
4. Zatvorite vrata.
5. Pritisnite tipku Start/Pauza, nakon 10 sekundi, perilica će nastaviti s radom.

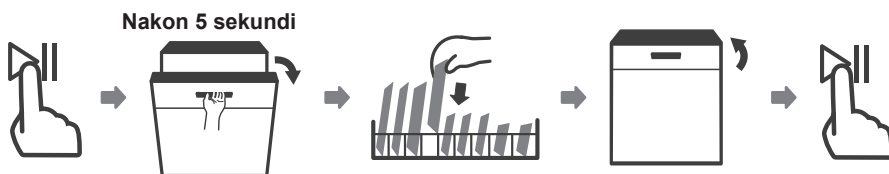

### ⚠ UPOZORENJE



Opasno je otvarati vrata tijekom pranja, jer bi vas vruća voda mogla opeći.

# KODOVI POGREŠAKA

Uređaj vas o eventualnim nepravilnostima ili kvarovima obavještava na sljedeći način:

Kodovi	Značenja	Mogući uzroci
E1	Duže vrijeme dovoda vode.	Slavina nije otvorena, dovod vode je slabiji ili je pritisak prenizak.
E3	Nije dosegnuta podešena temperatura.	Kvar grijača.
E4	Curenje.	Iz nekog dijela perilice curi.
Ed	Greška u komunikaciji između glavne tiskane ploče i tiskane ploče pokazivača.	Otvoreni krug ili prekinuta žica komunikacijskog sklopa.

## **⚠ UPOZORENJE**

- Dođe li do prelijevanja, prije pozivanja servisa zatvorite glavni dovod vode.
- Ako u perilici ima vode uslijed prelijevanja ili manjeg curenja, uklonite je prije ponovnog pokretanja perilice.
- Ako postoji kod pogreške koji se ne može riješiti, zatražite stručnu pomoć.

# TEHNIČKI PODACI

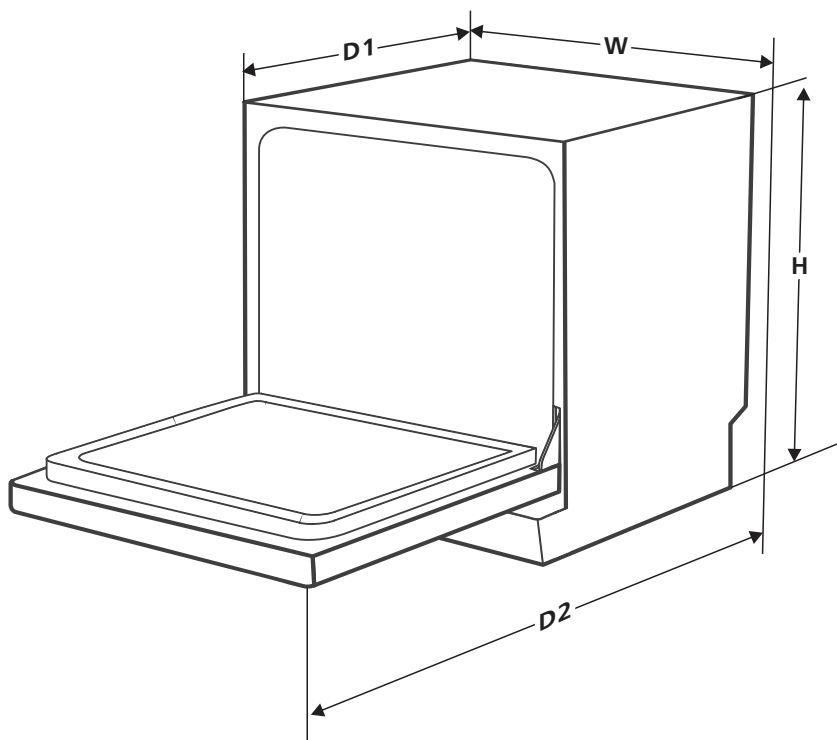

<b>Visina (H)</b>	438mm
<b>Širina (W)</b>	550mm
<b>Dubina (D1)</b>	500mm (sa zatvorenim vratima)
<b>Dubina (D2)</b>	812mm (s vratima otvorenim 90°)



<b>Informacijski list proizvoda</b>				
Uredba (EU) 2019/2017				
<b>Ime ili zaštitni znak dobavljača: KONČAR</b>				
<b>Adresa dobavljača: KONČAR - KUĆANSKI APARATI d.d. , Slavonska avenija 16 , 10000 Zagreb , Hrvatska</b>				
<b>Identifikacijska oznaka modela: PP55TBMD6</b>				
<b>Opći parametri proizvoda</b>				
Parametar	Vrijednost	Parametar	Vrijednost	
Nazivni kapacitet (ps)	6	Dimenzije u centimetrima	Visina	44
			Širina	55
			Dubina	50
EEI	61,9	Razred energetske učinkovitosti	F	
Indeks učinkovitosti pranja	1,125	Indeks učinkovitosti sušenja	1,065	
Potrošnja energije u kWh [po ciklusu], na temelju eco programa uz upotrebu hladne vode. Stvarna potrošnja energije ovisit će o tome kako se uređaj upotrebljava.	0,613	Potrošnja vode u litrama [po ciklusu], na temelju eco programa. Stvarna potrošnja vode ovisit će o tome kako se uređaj upotrebljava i o tvrdoći vode.	6,5	
Trajanje programa (h:min)	3:50	Vrsta	samostojeći	
Emisije buke koja se prenosi zrakom (dB(A) re 1 pW)	49	Razred emisije buke koja se prenosi zrakom	C	
Stanje isključenosti (W)	0,49	Stanje pripravnosti (W)	-	
Odgođeni početak rada (W) (ako je primjenjivo)	1,00	Umreženi odgođeni početak rada (W) (ako je primjenjivo)	-	
<b>Minimalno trajanje jamstva koje nudi proizvođač: 60 mjeseci</b>				
<b>Dodatne informacije</b>				
<b>Poveznica na internetsku stranicu proizvođača: <a href="http://www.koncar-ka.hr">www.koncar-ka.hr</a></b>				



**KONČAR - KUĆANSKI APARATI d.d.**

Slavonska avenija 16 , 10001 Zagreb , Hrvatska

tel : ++ 385 1/2484 555

fax : ++ 385 1/2404 102

[www.koncar-ka.hr](http://www.koncar-ka.hr)

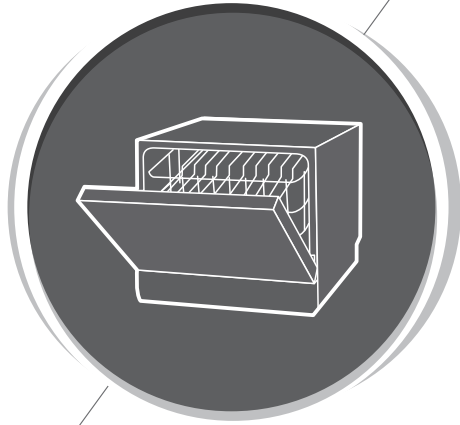

# **Dishwasher** Instruction Manual

## **PART I : Generic Version**

Please read this manual carefully before using the dishwasher  
Keep this manual for future reference.

# CONTENTS

01	3	<b>SAFETY INFORMATION</b>
02	8	<b>PRODUCT OVERVIEW</b>
03	9	<b>USING YOUR DISHWASHER</b>
	9	Loading The Salt Into The Softener
04	11	<b>MAINTENANCE AND CLEANING</b>
	11	External Care
	11	Internal Care
	14	Caring For The Dishwasher
05	15	<b>INSTALLATION INSTRUCTION</b>
	15	About Power Connection
	16	Water Supply And Drain
	17	Connection Of Drain Hoses
	18	Positioning The Appliance
06	19	<b>TROUBLESHOOTING TIPS</b>
	22	Availability Of Spare Parts
07	23	<b>LOADING THE BASKETS</b>



## NOTE:

- Reviewing the section on **Troubleshooting Tips** will help you solve some common problems by yourself.
- If you cannot solve the problems by yourself, please ask for help from a professional technician.
- The manufacturer, following a policy of constant development and updating of the product, may make modifications without giving prior notice.
- If lost or out-of-date, you can receive a new user manual from the manufacturer or responsible vendor.

# SAFETY INFORMATION

## **⚠ WARNING**

**When using your dishwasher, follow the precautions listed below:**

- Installation and repair can only be carried out by a qualified technician
- This appliance is intended to be used in household and similar applications such as:
  - staff kitchen areas in shops, offices and other working environments;
  - farm houses;
  - by clients in hotels, motels and other residential type environments;
  - bed and breakfast type environments.
- **This appliance can be used by children aged from 8 years and above and persons with reduced physical, sensory or mental capabilities or lack of experience and knowledge if they have been given supervision or instruction concerning use of the appliance in a safe way and understand the hazards involved.** Children shall not play with the appliance. Cleaning and user maintenance shall not be done by children without supervision. (For EN60335-1)
- This appliance is not intended for use by persons (including children) with reduced physical, sensory or mental capabilities, or lack of experience and knowledge, unless they have been given supervision or instruction concerning use of the appliance by a person responsible for their safety. (For IEC60335-1)

- Packaging material could be dangerous for children!
- Children should be supervised to ensure that they do not play with the appliance.
- This appliance is for indoor household use only. To protect against the risk of electrical shock, do not immerse the unit, cord or plug in water or other liquid.
- Please unplug before cleaning and maintenance the appliance .Use a soft cloth moisten with mild soap, and then use a dry cloth to wipe it again.
- If the supply cord is damaged, it must be replaced by the manufacturer or its service agent or a similarly qualified person in order to avoid a hazard.



## Earthing Instructions

---

- This appliance must be earthed. In the event of a malfunction or breakdown, earthing will reduce the risk of an electric shock by providing a path of least resistance of electric current. This appliance is equipped with an earthing conductor plug.
- The plug must be plugged into an appropriate outlet that is installed and earthed in accordance with all local codes and ordinances.
- Improper connection of the equipment-earthing conductor can result in the risk of an electric shock.
- Check with a qualified electrician or service representative if you are in doubt whether the appliance is properly grounded.

- Do not modify the plug provided with the appliance if it does not fit the outlet.
- Have a proper outlet installed by a qualified electrician.
- Do not abuse, sit on, or stand on the door or dish rack of the dishwasher.
- Do not operate your dishwasher unless all enclosure panels are properly in place.
- Open the door very carefully if the dishwasher is operating, there is a risk of water squirting out.
- Do not place any heavy objects on or stand on the door when it is open. The appliance could tip forward.
- When loading items to be washed:
  - 1) Locate sharp items so that they are not likely to damage the door seal;
  - 2) Warning: Knives and other utensils with sharp points must be loaded in the basket with their points facing down or placed in a horizontal position.
- Some dishwasher detergents are strongly alkaline. They can be extremely dangerous if swallowed. Avoid contact with the skin and eyes and keep children away from the dishwasher when the door is open.
- Check that there are no detergent residues after completion of the wash cycle.
- Do not wash plastic items unless they are marked "dishwasher safe" or the equivalent.

- For unmarked plastic items not so marked, check the manufacturer's recommendations.
- Use only detergent and rinse agents recommended for use in an automatic dishwasher.
- Never use soap, laundry detergent, or hand washing detergent in your dishwasher.
- The door should not be left open, since this could increase the risk of tripping.
- During installation, the power supply must not be excessively or dangerously bent or flattened.
- Do not tamper with controls.
- The appliance needs to be connected to the main water valve using new hose sets. Old sets should not be reused.
- To save energy, in stand by mode, the appliance will switch off automatically after 15 minutes without any user interaction.
- The maximum number of place settings to be washed is 6.
- The maximum permissible inlet water pressure is 1MPa.
- The minimum permissible inlet water pressure is 0.04MPa.



## Disposal

---

- For disposing of package and the appliance please go to a recycling center. Therefore cut off the power supply cable and make the door closing device unusable.



- Cardboard packaging is manufactured from recycled paper and should be disposed in the waste paper collection for recycling.
- By ensuring this product is disposed of correctly, you will help prevent potential negative consequences for the environment and human health, which could otherwise be caused by inappropriate waste handling of this product.
- For more detailed information about recycling of this product, please contact your local city office and your household waste disposal service.
- **DISPOSAL: Do not dispose this product as unsorted municipal waste. Collection of such waste separately for special treatment is necessary.**

# PRODUCT OVERVIEW

## ❗ IMPORTANT:

To get the best performance from your dishwasher, read all operating instructions before using it for the first time.

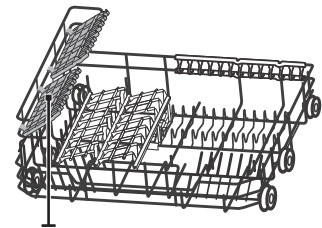
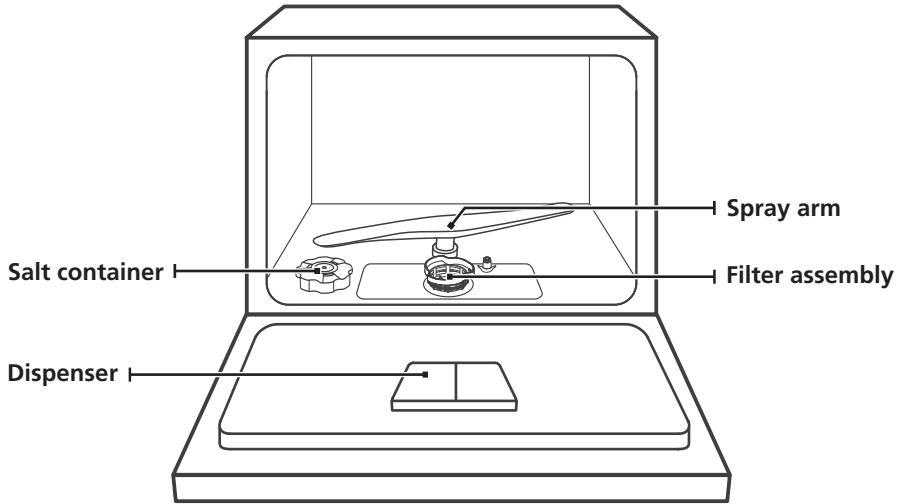

Cup rack

Basket

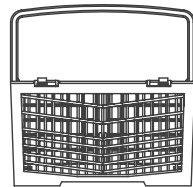

Cutlery rack

## 💡 NOTE:

Pictures are only for reference, different models may be different.

# USING YOUR DISHWASHER

Before using your dishwasher :

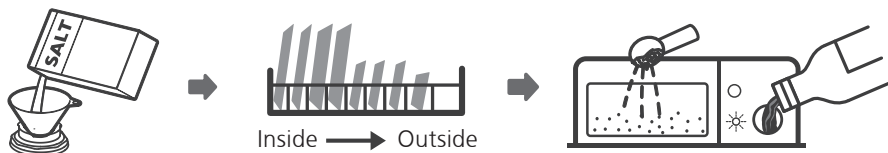

1. Set the water softener
2. Loading the salt into the softener
3. Loading the basket
4. Fill the **detergent** dispenser



Please check the section 1 “Water Softener” of PART II : Special Version, if you need to set the water softener .

## Loading The Salt Into The Softener

### NOTE:

If your model does not have any water softener, you may skip this section. Always use salt intended for dishwasher use. The salt container is located beneath the lower basket and should be filled as explained in the following:

### WARNING

- **Only use salt specifically designed for dishwashers use!**  
Every other type of salt not specifically designed for dishwasher use, especially table salt, will damage the water softener. In case of damages caused by the use of unsuitable salt the manufacturer does not give any warranty nor is liable for any damages caused.
- **Only fill with salt before running a cycle.**  
This will prevent any grains of salt or salty water, which may have been spilled, remaining on the bottom of the machine for any period of time, which may cause corrosion.

Please follow the steps below for adding dishwasher salt:

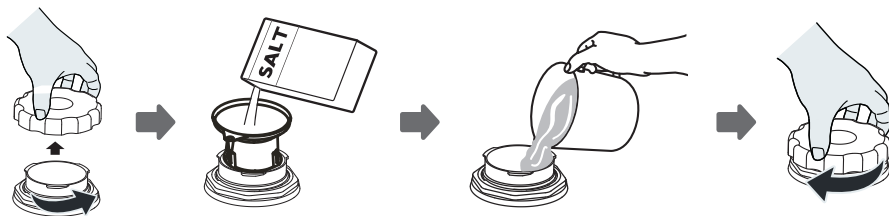

1. Remove the lower basket and unscrew the reservoir cap.
2. Place the end of the funnel (if supplied) into the hole and pour in about 1 kg of dishwasher salt.
3. Fill the salt container to its maximum limit with water, It is normal for a small amount of water to come out of the salt container.
4. After filling the container, screw back the cap tightly.
5. The salt warning light will **turn off** after the salt container has been filled with salt.
6. Immediately after filling the salt into the salt container, a washing program should be started (We suggest to use a short program). Otherwise the filter system, pump or other important parts of the machine may be damaged by salty water. This is out of warranty.

 **NOTE:**

- The salt container must only be refilled when the salt warning light (  ) in the control panel comes on. Depending on how well the salt dissolves, the salt warning light may still be on even though the salt container is filled. If there is no salt warning light in the control panel (for some **models**), you can estimate when to fill the salt into the softener by the cycles that the dishwasher has run.
- If salt has spilled, run a soak or quick program to remove it.

# MAINTENANCE AND CLEANING

## External Care

---

### The door and the door seal

Clean the door seals regularly with a soft damp cloth to remove food deposits. When the dishwasher is being loaded, food and drink residues may drip onto the sides of the dishwasher door. These surfaces are outside the wash cabinet and are not accessed by water from the spray arms. Any deposits should be wiped off before the door is closed.

### The control panel

If cleaning is required, the control panel should be wiped with a soft damp cloth only.

#### **WARNING**

- To avoid penetration of water into the door lock and electrical components, do not use a spray cleaner of any kind.
- Never use abrasive cleaners or scouring pads on the outer surfaces because they may scratch the finish. Some paper towels may also scratch or leave marks on the surface.

## Internal Care

---

### Filtering system

The filtering system in the base of the wash cabinet retains coarse debris from the washing cycle, including foreign objects such as tooth picks or shards. The collected coarse debris may cause the filters to clog. Check the condition of the filters regularly, carefully remove foreign objects and clean the parts of the filtering system if necessary with water. Follow the steps below to clean the filter.

#### **NOTE:**

Pictures are only for reference, different models of the filtering system and spray arms may be different.

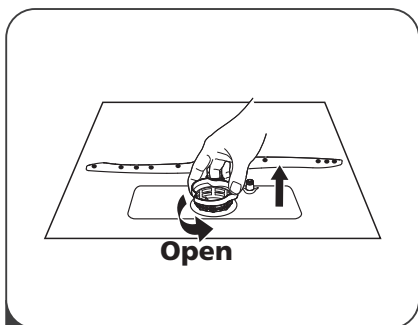

- 1** Hold the coarse filter and rotate it anticlockwise to unlock the filter. Lift the filter upwards and out of the dishwasher.

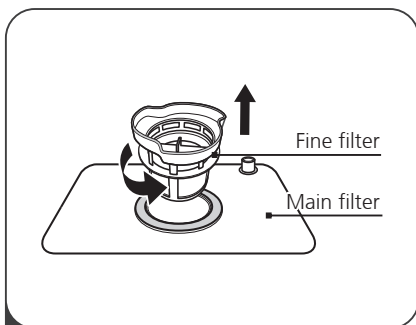

- 2** Lift fine filter up from main filter.

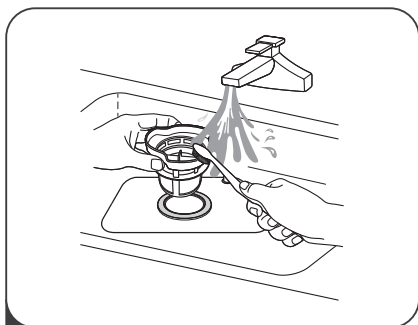

- 3** Larger food remnants can be cleaned by rinsing the filter under running water. For a more thorough clean, use a soft cleaning brush.

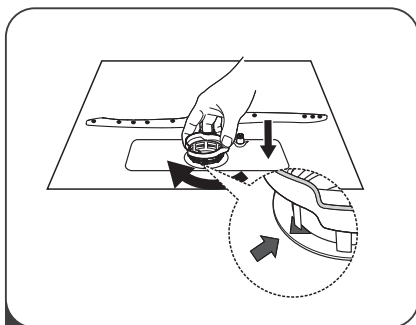

- 4** Reassemble the filters in the reverse order of the disassembly, replace the filter insert, and rotate clockwise to the close arrow.

**⚠ WARNING**

- Do not over tighten the filters. Put the filters back in sequence securely, otherwise coarse debris could get into the system and cause a blockage.
- NEVER use the dishwasher without filters in place. Improper replacement of the filter may reduce the performance level of the appliance and damage dishes and utensils.

## Spray arm

It is necessary to clean the spray arm regularly for hard water chemicals will clog the spray arm jets and bearings.

To clean the spray arm, follow the instructions below:

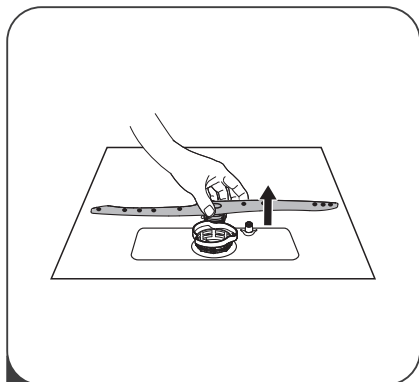

- 1 To remove the spray arm, pull out the spray arm upward.

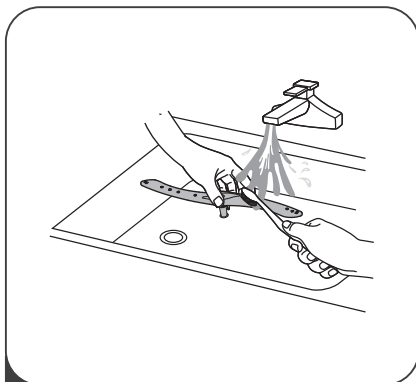

- 2 Wash the spray arm in soapy and warm water and use a soft brush to clean the jets. Replace them after rinsing them thoroughly.

## Caring For The Dishwasher

### Frost precaution

please take frost protection measures on the dishwasher in winter. Every after washing cycles, please operate as follows:

1. Cut off the electrical power to the dishwasher at the supply source.
2. Turn off the water supply and disconnect the water inlet pipe from the water valve.
3. Drain the water from the inlet pipe and water valve. (Use a pan to gather the water)
4. Reconnect the water inlet pipe to the water valve.
5. Remove the filter at the bottom of the tub and use a sponge to soak up water in the sump.

### After every wash

After every wash, turn off the water supply to the appliance and leave the door slightly open **for a while** so that moisture and odors are not trapped inside.

## **Remove the plug**

Before cleaning or performing maintenance, always remove the plug from the socket.

## **No solvents or abrasive cleaning**

To clean the exterior and rubber parts of the dishwasher, do not use solvents or abrasive cleaning products. Only use a cloth with warm soapy water.

To remove spots or stains from the surface of the interior, use a cloth dampened with water and a little vinegar, or a cleaning product made specifically for dishwashers.

## **When not in use for a long time**

It is recommended that you run a wash cycle with the dishwasher empty and then remove the plug from the socket, turn off the water supply and leave the door of the appliance slightly open. This will help the door seals to last longer and prevent odors from forming within the appliance.

## **Moving the appliance**

If the appliance must be moved, try to keep it in the vertical position. If absolutely necessary, it can be positioned on its back.

## **Seals**

One of the factors that cause odours to form in the dishwasher is food that remains trapped in the seals. Periodic cleaning with a damp sponge will prevent this from occurring.



# INSTALLATION INSTRUCTION

## ⚠ WARNING



### Electrical Shock Hazard

Disconnect electrical power before installing dishwasher.

Failure to do so could result in death or electrical shock.

## ⚠ Attention

The installation of the pipes and electrical equipments should be done by professionals.

## About Power Connection

## ⚠ WARNING

For personal safety:

- Do not use an extension cord or an adapter plug with this appliance.
- Do not, under any circumstances, cut or remove the earthing connection from the power cord.

### Electrical requirements

Please look at the rating label to know the rating voltage and connect the dishwasher to the appropriate power supply. Use the required fuse 10A/13A/16A, time delay fuse or circuit breaker recommended and provide separate circuit serving only this appliance.

### Electrical connection

Ensure the voltage and frequency of the power being corresponds to those on the rating plate. Only insert the plug into an electrical socket which is earthed properly. If the electrical socket to which the appliance must be connected is not appropriate for the plug, replace the socket, rather than using a adaptors or the like as they could cause overheating and burns.

⚠ Ensure that proper earthing exists before use

# Water Supply And Drain

## Cold water connection

Connect the cold water supply hose to a threaded 3/4(inch) connector and make sure that it is fastened tightly in place.

If the water pipes are new or have not been used for an extended period of time, let the water run to make sure that the water is clear. This precaution is needed to avoid the risk of the water inlet to be blocked and damage the appliance.

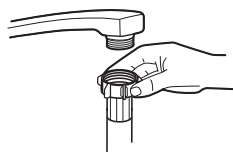

ordinary supply hose



safety supply hose

## About the safety supply hose

The safety supply hose consists of the double walls. The system guarantees its intervention by blocking the flow of water in case of the supply hose breaking and when the air space between the supply hose itself and the outer corrugated hose is full of water.

### **⚠ WARNING**

A hose that attaches to **tap** can burst if it is installed on the same water line as the dishwasher. If your sink has one, it is recommended that the hose be disconnected and the hole plugged.

## How to connect the safety supply hose

1. Pull **the** safety supply hoses out from storage compartment located at rear of dishwasher.
2. **Tighten** the screws of the safety supply hose to the faucet with thread 3/4inch.
3. Turn **the** water fully on before starting the dishwasher.

## How to disconnect the safety supply hose

1. Turn off the water.
2. Unscrew the safety supply hose from the faucet.

# Connection Of Drain Hoses

Insert the drain hose into a drain pipe with a minimum diameter of 4 cm, or let it run into the sink, making sure to avoid bending or crimping it. The height of drain pipe must be less than 600 mm. The free end of the hose must not be immersed in water to avoid the back flow of it.

**⚠** Please securely fix the drain hose in either position A or position B

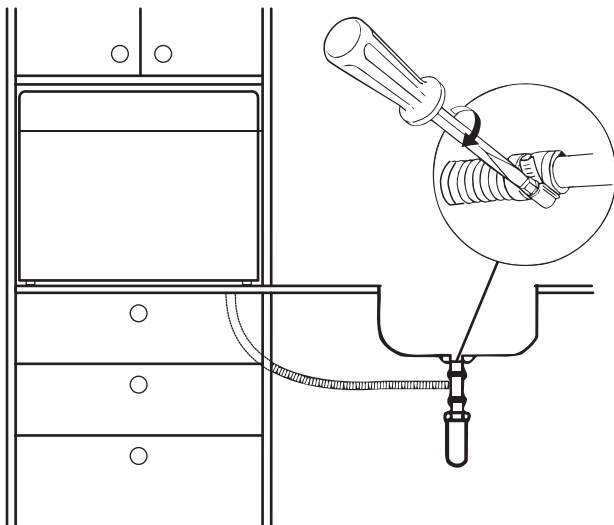
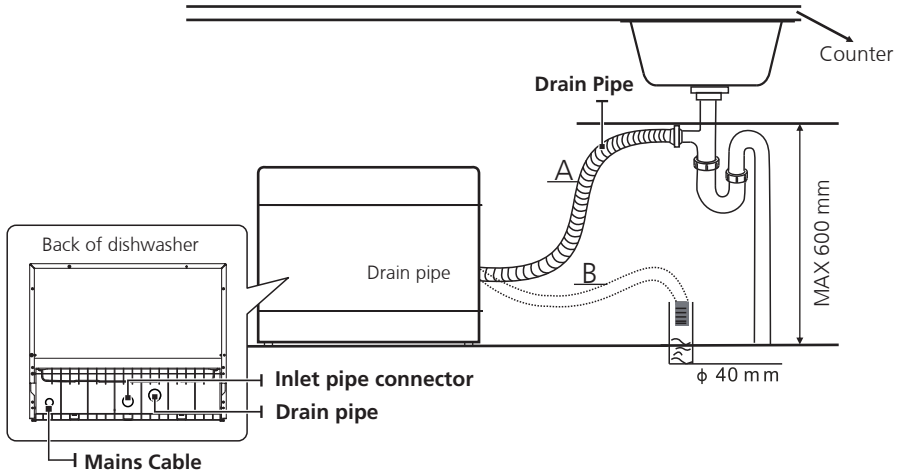

## How to drain excess water from hoses

If the connection to the drain pipe is positioned higher than 1000 mm, excess water may remain in the drain hose. It will be necessary to drain excess water from the hose into a bowl or suitable container that is held outside and lower than the sink.

## Water outlet

Connect the water drain hose. The drain hose must be correctly fitted to avoid water leaks. Ensure that the water drain hose is not kinked or squashed.

## Extension hose

If you need a drain hose extension, make sure to use a similar drain hose. It must be no longer than 4 meters; otherwise the cleaning effect of the dishwasher could be reduced.

## Syphon connection

The waste connection must be at a height less than 1000 mm (maximum) from the bottom of the dishwasher.

# Positioning The Appliance

---

Position the appliance in the desired location. The back should rest against the wall behind it, and the sides, along the adjacent cabinets or walls. The dishwasher is equipped with water supply and drain hoses that can be positioned either to the right or the left sides to facilitate proper installation.

# TROUBLESHOOTING TIPS

## Before Calling For Service

Reviewing the charts on the following pages may save you from calling for service.

Problem	Possible causes	Solution
Dishwasher doesn't start	Fuse blown, or the circuit breaker tripped.	Replace fuse or reset circuit breaker. Remove any other appliances sharing the same circuit with the dishwasher.
	Power supply is not turned on.	Make sure the dishwasher is turned on and the door is closed securely. Make sure the power cord is properly plugged into the wall socket.
	Door of dishwasher not properly closed.	Make sure to close the door properly and latch it.
Water not pumped from dishwasher	Kink in drain hose	Check drain hose.
	Filter clogged.	Check the coarse filter. (see section titled " Internal Care ")
	Kitchen sink clogged.	Check the kitchen sink to make sure it is draining well. If the problem is the kitchen sink that is not draining , you may need a plumber rather than a serviceman for dishwashers.
Foam in the tub	Improper detergent	Use only the special dishwasher detergent to avoid suds. If this occurred, open the dishwasher and let suds evaporate. Add 1 gallon of cold water to the tub. Close and latch the dishwasher, then Start any wash cycle to drain out the water. Repeat if necessary.
	Spilled <b>rinse aid</b> .	Always wipe up <b>rinse aid</b> spills immediately.
Stained tub interior	Detergent with colourant may have been used.	Make sure that the detergent has no colourant.
White film on inside surface	Hard water minerals.	To clean the interior, use <b>the damp soft cloth</b> with dishwasher detergent and wear rubber gloves. Never use any other cleaner than dishwasher detergent for the risk of foaming or suds.

<b>Problem</b>	<b>Possible Causes</b>	<b>What To Do</b>
There are rust stains on cutlery	The affected items are not corrosion resistant.	Avoid washing items that are not corrosion resistant in the dishwasher.
	A program was not run after dishwasher salt was added. Traces of salt have gotten into the wash cycle.	Always run the quick wash program. without any crockery in the dishwasher and without selecting the Turbo function (if present), after adding dishwasher salt.
	The lid of the softer is loose.	Check the lip. Ensure the fix is fine.
Knocking noise in the wash cabinet	The spray arm is knocking against an item in a basket.	Interrupt the program, and rearrange the items which are obstructing the spray arm.
Rattling noise in the wash cabinet	Item of crockery are loose in the wash cabinet.	Interrupt the program, and rearrange the items of crockery.
Knocking noise in the water pipes	This may be caused by on-site installation or the cross-section of the piping.	This has no influence on the dishwasher function. If in doubt, contact a qualified plumber.
The dishes are not clean	The dishes were not loaded correctly.	See PART II "Preparing And Loading Dishes".
	The program was not powerful enough.	Select a more intensive program.
	Not enough detergent was dispensed.	Use more detergent, or change your detergent.
	Item are blocking the path of spray arms.	Rearrange the items so that the spray can rotate freely.
	The filter combination in the base of wash cabinet is not clean or is not correctly fitted. This may cause the spray arm jets to get blocked.	Clean and/or fit the filter correctly. Clean the spray arm jets.

Problem	Possible Causes	What To Do
Cloudiness on glassware.	Combination of soft water and too much detergent.	Use less detergent if you have soft water and select a shorter cycle to wash the glassware and to get them clean.
Black or grey marks on dishes	Aluminium utensils have rubbed against dishes	Use a mild abrasive cleaner to eliminate those marks.
Detergent left in dispenser cups	Dishes block detergent dispenser cups	Re-loading the dishes properly.
The dishes are not drying	Improper loading	<b>Use gloves if detergent residue can be found on dishes to avoid skin irritations.</b>
	Dishes are removed too soon	Do not empty your dishwasher immediately after washing. Open the door slightly so that the steam can escape. Begin unloading the dishwasher only once the dishes are barely warm to the touch. Empty the low basket first. This prevents water from dropping off dishes in the upper basket.
	Wrong program has been selected.	In short programs the washing temperature is lower. This also lowers cleaning performance. Choose a program with a long washing time.
	Use of cutlery with a low-quality coating.	Water drainage is more difficult with these items. Cutlery or dishes of this type are not suitable for washing in the dishwasher.

**⚠ WARNING**

Self-repair or non-professional repair may cause serious risks to the safety of the user of the appliance and impact warranty.

# Availability Of Spare Parts

---

- **Seven years after placing the last unit of the model on the market:**  
Motor, circulation and drain pump, heaters and heating elements, including heat pumps (separately or bundled), piping and related equipment including all hoses, valves, filters and aqua stops, structural and interior parts related to door assemblies (separately or bundled), printed circuit boards, electronic displays, pressure switches, thermostats and sensors, software and firmware including reset software.
- **Ten years after placing the last unit of the model on the market:**  
Door hinge and seals, other seals, spray arms, drain filters, interior racks and plastic peripherals such as baskets and lids.



# LOADING THE BASKETS ACCORDING TO EN60436:

Loading the dishwasher to its full capacity will contribute to energy and water savings.

## 1. Basket:

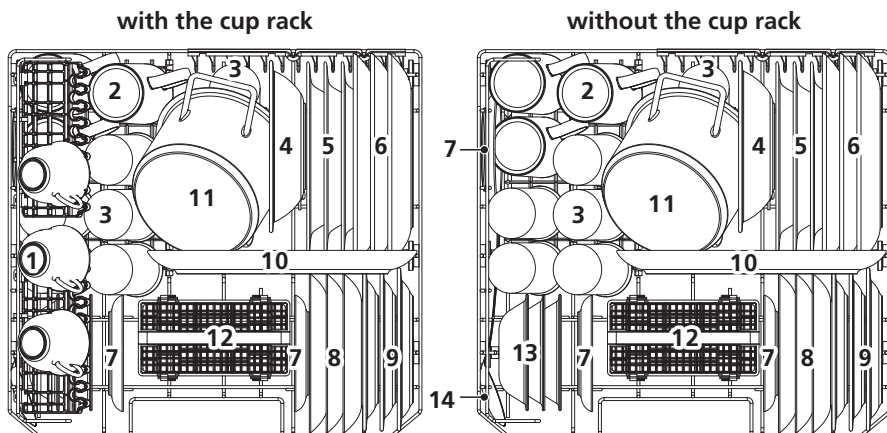

Number	Item
1	Cups
2	Mugs
3	Glasses
4	Melamine bowl
5	Soup plates
6	Dinner plates
7	Saucers

Number	Item
8	Dessert dishes
9	Melamine dessert plates
10	Oval platter
11	Small pot
12	Cutlery basket
13	Dessert bowls
14	Serving spoon

## 2.Cutlery basket:

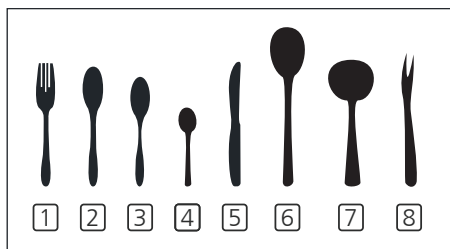
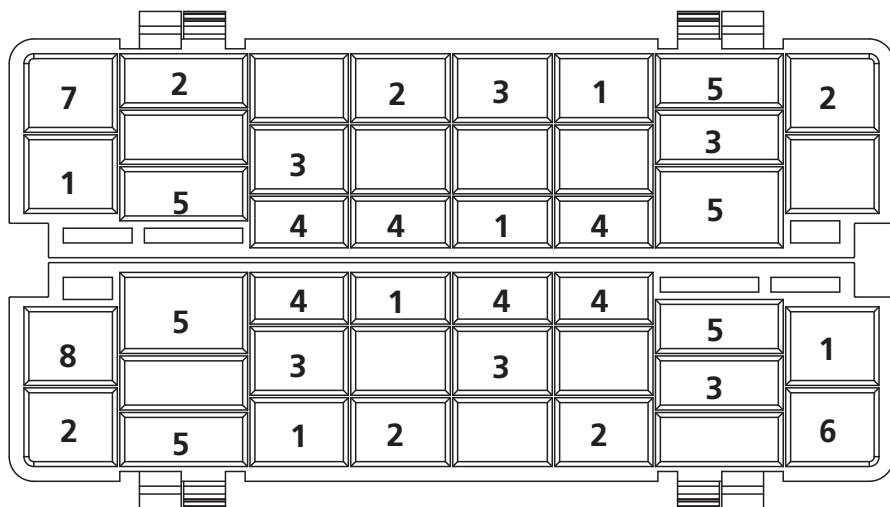

Information for comparability tests  
in accordance with EN60436

- Capacity: 6 place settings
- Program: ECO
- Rinse aid setting: Max
- Softener setting: H4

Number	Item
1	Forks
2	Soup spoons
3	Dessert spoons
4	Teaspoons
5	Knives
6	Serving spoons
7	Gravy ladles
8	Serving forks

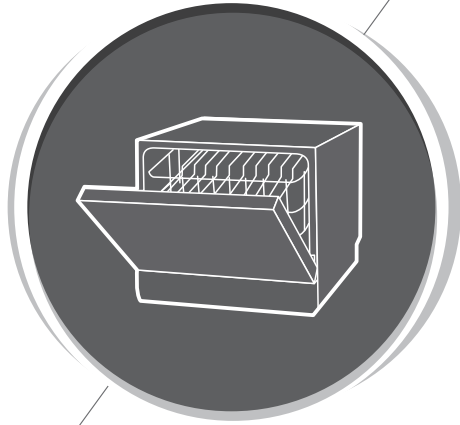

# Dishwasher

## Instruction Manual

**PART II: Special Version**  
**PP55TBMD6**

**KONČAR**

Please read this manual carefully  
before using the dishwasher and  
Keep this manual for future reference.

# CONTENTS

01	4	<b>USING YOUR DISHWASHER</b>
	4	Control Panel
	6	Water Softener
	7	Preparing And Loading Dishes
	10	Function Of The Rinse Aid And Detergent
02	11	Filling The Rinse Aid Reservoir
	12	Filling The Detergent Dispenser
	13	<b>PROGRAMMING THE DISHWASHER</b>
	13	Wash Cycle Table
	14	<b>Saving Energy</b>
03	14	Starting A <b>Programme</b>
	14	Changing The Program Mid-cycle
	15	Forget To Add A Dish?
04	16	<b>ERROR CODES</b>
	17	<b>TECHNICAL INFORMATION</b>



## NOTE:

- If you cannot solve the problems by yourself, please ask for help from a professional technician.
- The manufacturer, following a policy of constant development and updating of the product, may make modifications without giving prior notice.
- If lost or out-of-date, you can receive a new user manual from the manufacturer or responsible vendor.

# QUICK USER GUIDE

Please read the corresponding content on the instruction manual for detailed operating method.

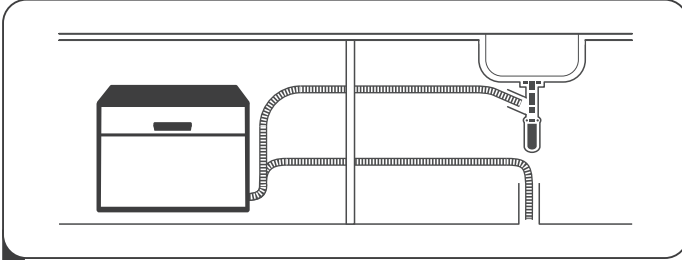

- 1 Install the dishwasher  
**(Please check the section 5 "INSTALLATION INSTRUCTION" of PART I : Generic Version.)**



- 2 Remove larger residue from dishes.  
Avoid pre-rinsing.

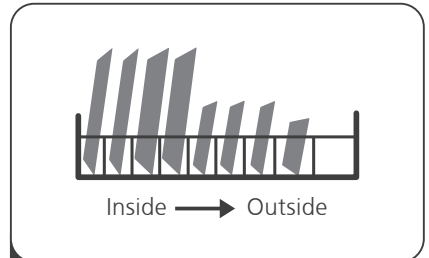

- 3 Load the baskets

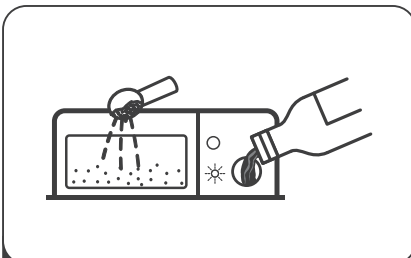

- 4 Fill the dispenser with detergent and rinse aid.

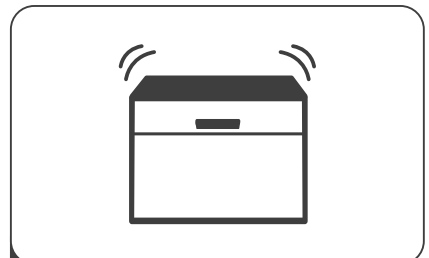

- 5 Select a suitable programme and start the dishwasher.

# USING YOUR DISHWASHER

## Control Panel

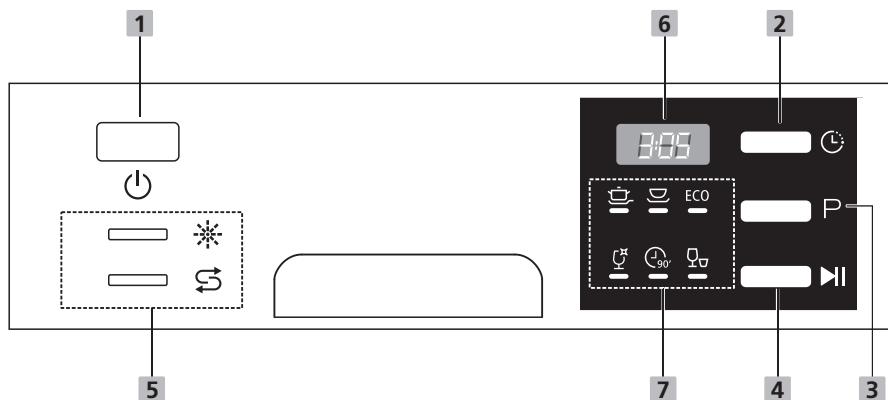









### Operation (Button)

<b>1 Power</b>	Press this button to turn on your dishwasher.
<b>2 Delay</b>	Press this button to set the delayed hours for washing. You can delay the start of washing up to 24 hours. One press on this button delays the start of washing by one hour.
<b>3 Program</b>	Press this button to select the appropriate washing programme, the programme indicator will be lit.
<b>4 Start / Pause</b>	To start the selected washing program or pause it when the dishwasher is working.

### Display

<b>5 Warning indicator</b>	 <b>Rinse Aid</b> If the " * " indicator is lit, it means the dishwasher is low on dishwasher rinse aid and requires a refill.
----------------------------	--

<p><b>5</b> <b>Warning indicator</b></p>	<p> <b>Salt</b> If the "  " indicator is lit, it means the dishwasher is low on dishwasher salt and needs to be refilled.</p>
<p><b>6</b> </p>	<p>To show the reminding time and delay time, error codes etc.</p>
<p><b>7</b> <b>Program indicator</b></p>	<p> <b>Intensive</b> For heaviest soiled crockery, and normally soiled pots, pans, dishes etc. With dried-on food.</p> <p> <b>Universal</b> For normally soiled loads, such as pots, plates, glasses and lightly soiled pans.</p> <p><b>ECO ECO</b> This is standard program, it is suitable to clean normally soiled tableware and it is the most efficient program in terms of its combined energy and water consumption for that type of tableware.</p> <p> <b>Glass</b> For lightly soiled crockery and glass.</p> <p> <b>90 Min</b> For normally soiled loads that need quick wash.</p> <p> <b>Rapid</b> A shorter wash for lightly soiled loads that do not need drying.</p>

# Water Softener

The water softener must be set manually, using the water hardness dial.

The water softener is designed to remove minerals and salts from the water, which would have a detrimental or adverse effect on the operation of the appliance.

The more minerals there are, the harder your water is.

The softener should be adjusted according to the hardness of the water in your area.

Your local Water Authority can advise you on the hardness of the water in your area.

## Adjusting salt consumption

The dishwasher is designed to allow for adjustment in the amount of salt consumed based on the hardness of the water used. This is intended to optimise and customise the level of salt consumption.

Please follow the steps below for adjustment in salt consumption.

1. Close the door, switch on the appliance;
2. Within 60 seconds after the appliance was switched on, press the Programme button for more than 5 seconds to start the water softener setting mode ;
3. Press the Program button again to select the proper setting according to your local environment, the setting will change in the following sequence:  
H1->H2->H3->H4->H5->H6;
4. Without any operation in five seconds or press the Power button to end the setting mode, the setting is memorized by the programme.

WATER HARDNESS		Setting on the water softener	Digital display stalls	Regeneration occurs every X program sequence <sup>3)</sup>
°dH <sup>1)</sup>	Mmol/l <sup>2)</sup>			
0 - 5	0 - 0.9	1	H1	No regeneration
6 - 11	1.0 - 2.0	2	H2	10
12 - 17	2.1 - 3.0	3	H3	5
18 - 22	3.1 - 4.0	4 *	H4	3
23 - 34	4.1 - 6.1	5	H5	2
35 - 45	6.2 - 8.0	6	H6	1

1) German degree of measurement for the water hardness

2) millimol, international unit for water hardness

3) Every cycle with a regeneration operation consumes additional 2.0 litres of water, the energy consumption increases by 0.02 kWh and the program extends by 4 minutes.

\* factory setting





Please check the section 3 “Loading The Salt Into The Softener” of PART I : Generic Version, If your dishwasher lacks salt.



## NOTE:

**If your model does not have any water softener, you may skip this section.**

### Water Softener

The hardness of the water varies from place to place. If hard water is used in the dishwasher, deposits will form on the dishes and utensils.

The appliance is equipped with a special softener that uses a salt container specifically designed to eliminate lime and minerals from the water.

## Preparing And Loading Dishes

---

- Consider buying utensils which are identified as dishwasher-proof.
- For particular items, select a program with the lowest possible temperature.
- To prevent damage, do not take glass and cutlery out of the dishwasher immediately after the program has ended.

### For washing the following cutlery/dishes

#### Are not suitable

- Cutlery with wooden, horn china or mother-of-pearl handles
- Plastic items that are not heat resistant
- Older cutlery with glued parts that are not temperature resistant
- Bonded cutlery items or dishes
- Pewter or cooper items
- Crystal glass
- Steel items subject to rusting
- Wooden platters
- Items made from synthetic fibres

#### Are of limited suitability

- Some types of glasses can become dull after a large number of washes
- Silver and aluminum parts have a tendency to discolour during washing
- Glazed patterns may fade if machine washed frequently

## Recommendations for loading the dishwasher

Scrape off any large amounts of leftover food. Soften remnants of burnt food in pans. It is not necessary to rinse the dishes under running water.

For best performance of the dishwasher, follow these loading guidelines.

**(Features and appearance of baskets and cutlery baskets may vary from your model.)**

Place objects in the dishwasher in **the** following way:

- Items such as cups, glasses, pots/pans, etc. **must face** downwards.
- Curved items, or ones with recesses, should be loaded aslant so that water can run off.
- All utensils are stacked securely and can not tip over.
- All utensils are placed in the way that the spray arms can rotate freely during washing.
- Load hollow items such as cups, glasses, pans etc. With the opening facing downwards so that water cannot collect in the container or a deep base.
- Dishes and items of cutlery must not lie inside one another, or cover each other.
- To avoid damage, glasses should not touch one another.
- The upper basket is designed to hold more delicate and lighter dishware such as glasses, coffee and tea cups.
- Long bladed knives stored in an upright position are a potential hazard!
- Long and / or sharp items of cutlery such as carving knives must be positioned horizontally in the upper basket.
- Please do not overload your dishwasher. This is important for good results and for reasonable consumption of energy.

### **NOTE:**

Very small items should not be washed in the dishwasher as they could easily fall out of the basket.

### **WARNING**



**Items will be hot!** To prevent damage, do not take glass and cutlery out of the dishwasher for around 15 minutes after the program has ended.

## Loading the basket

All tableware can't be placed face up, in order to improve the cleaning area and washing performance, it is recommended to place the dirty side towards the spray arm.

Please don't let tableware out of basket bottom to make sure not block the moving of the spray arm. The maximum diameter advised for plates in front of the detergent dispenser is of 19 cm, this not to hamper the opening of it.



## Loading the cutlery basket

For personal safety and a top quality cleaning, place the silverware in the basket making sure that:

- They do not nest together.
- Silverware is placed with the handles-down.
- But place knives and other potentially dangerous utensils are placed handles-up.

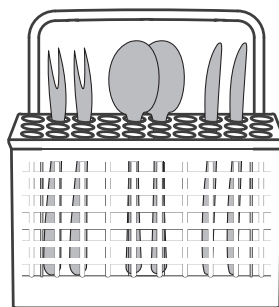

### **⚠ WARNING**



Do not let any item extend through the bottom.  
Always load sharp utensils with the sharp point down!



**For the best washing effect, please load the baskets refer to standard loading options on last section of PART I : Generic Version**

# Function Of The Rinse Aid And Detergent

The rinse aid is released during the final rinse to prevent water from forming droplets on your dishes, which can leave spots and streaks. It also improves drying by allowing water to **run** off the dishes. Your dishwasher is designed to use liquid rinse aids.

## ⚠ WARNING

Only use branded rinse aid for dishwasher. Never fill the rinse aid dispenser with any other substances (e.g. Dishwasher cleaning agent, liquid detergent). This would damage the appliance.

## When to refill the rinse aid dispenser

Unless the rinse-aid warning light (  ) on the control panel is on, you can always estimate the amount from the color of the optical level indicator located next to the cap. When the rinse-aid container is full, the indicator will be fully dark. The size of the dark dot decreases as the rinse-aid diminishes. You should never let the rinse aid level be less than 1/4 full.

As the rinse aid diminishes, the size of the black dot on the rinse aid level indicator changes, as illustrated below.

Full       3/4 full       1/2 full       1/4 full       Empty

## Function of detergent

The chemical ingredients that compose the detergent are necessary to remove, crush and dispense all dirt out of the dishwasher. Most of the commercial quality detergents are suitable for this purpose.

## ⚠ WARNING

- Proper Use of Detergent

Use only detergent specifically made for dishwashers use. Keep your detergent fresh and dry.

**Do not fill detergent into the dispenser until you are ready to start the dishwasher.**



- **Dishwasher detergent is corrosive! Keep dishwasher detergent out of the reach of children.**

## Filling The Rinse Aid Reservoir

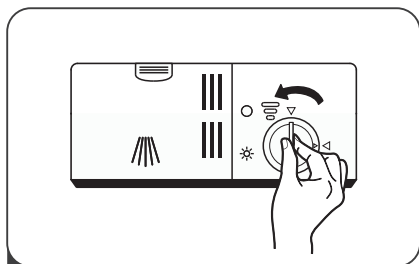

- 1** Remove the rinse aid reservoir cap by rotating it counterclockwise.

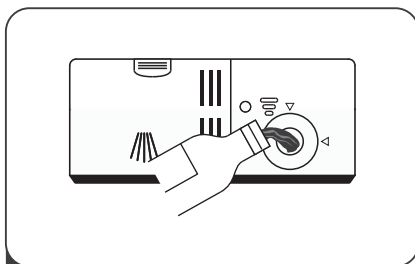

- 2** Carefully pour in the **rinse aid** into the dispenser, whilst avoiding it to overflow.

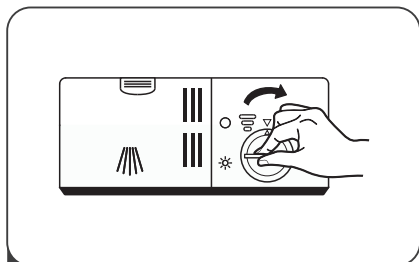

- 3** Close the rinse aid reservoir cap by rotating it clockwise.

### **NOTE:**

Clean up any spilled rinse aid with an absorbent cloth to avoid excessive foaming during the next wash.

## Adjusting the rinse aid reservoir

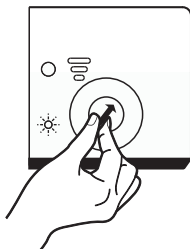

**Remove the rinse aid reservoir cap.** Turn the rinse aid indicator dial to a number. The higher the number, the more rinse aid the dishwasher uses.

If the dishes are not drying properly or are spotted, adjust the dial to the next higher number until your dishes are spot-free. Reduce it if there are sticky whitish stains on your dishes or a

# Filling The Detergent Dispenser

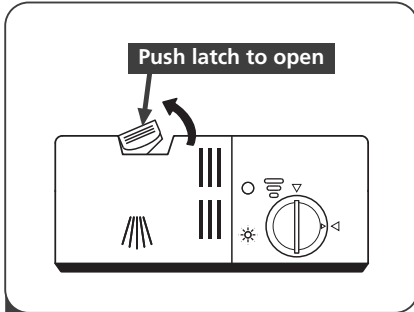

1 Press the release **latch** on the detergent dispenser to open the cover.

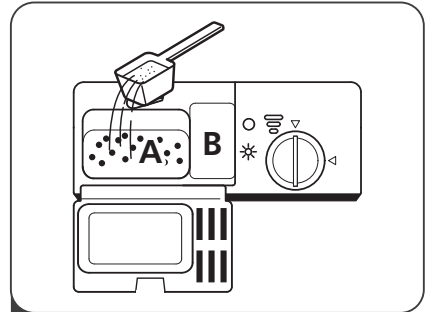

2 Add detergent into the larger cavity (A) for main wash. For more heavily soiled wash loads, also add some detergent into the smaller cavity (B) **for release during pre-wash.**

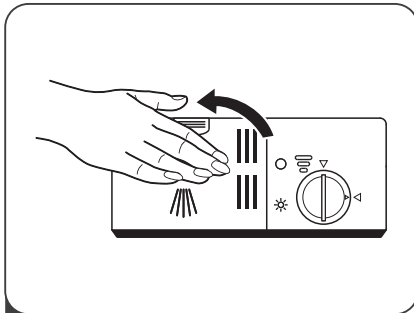

3 Close the cover and press on it until it locks into place.





## **NOTE:**

- **Please observe the manufacturer's recommendations on the detergent packaging.**

# Wash Cycle Table

The table below shows which programs are best for the levels of food residue on them and how much detergent is needed. It also show various information about the programs. Consumption values and program duration are only indicative except for ECO program.

(●) indicates that the program uses rinse aid in the last rinse.

Program	Description Of Cycle	Detergent Pre/Main Wash	Running Time(min)	Energy (kWh)	Water (L)	Rinse Aid
 Intensive	Pre-wash(50°C) Wash(70°C) Rinse Rinse Rinse(70°C) Drying	<u>4/10g</u> (1 tab)	140	0.894	9.6	●
 Universal	Pre-wash Wash(60°C) Rinse Rinse(70°C) Drying	<u>4/10g</u> (1 tab)	120	0.667	7.7	●
<b>ECO</b> (*EN 60436)	Pre-wash Wash(45°C) Rinse(65°C) Drying	<u>4/10g</u> (1 tab)	230	0.613	6.5	●
 Glass	Wash(45°C) Rinse Rinse(60°C) Drying	<u>14g</u> (1 tab)	75	0.435	5.8	●
 90 Min	Wash(65°C) Rinse Rinse Rinse(70°C) Drying	<u>14g</u> (1 tab)	90	0.785	6.6	●
 Rapid	Wash(40°C) Rinse Rinse	<u>12g</u> (1 tab)	30	0.244	5.8	○

## NOTE:

**ECO** : The ECO program is suitable to clean normally soiled tableware, that for this use, it is the most efficient program in terms of its combined energy and water consumption, and it is used to assess compliance with the EU ecodesign legislation.

## Saving Energy

---

1. Pre-rinsing of tableware items leads to increased water and energy consumption and is not recommended.
2. Washing tableware in a household dishwasher usually consumes less energy and water in the use phase than hand dishwashing when the household dishwasher is used according to the instructions.

## Starting A Programme

---

1. Draw out the basket, load the dishes and push them back.
2. Pour in the detergent.
3. Insert the plug into the socket. The power supply refer to last page "Product fiche". Make sure that the water supply is turned on to full pressure.
4. Close the door, press the Power button, to switch on the machine.
5. Choose a program, the response light will turn on. Then press the Start/Pause button, the dishwasher will start its cycle.

## Changing The Program Mid-cycle

---

A programme can only be changed if it has been running only for a short period of time, otherwise the detergent may have already been released or the the wash water with detergent has already been drained. If this is the case, the dishwasher needs to be reset and the detergent dispenser must be refilled. To reset the dishwasher, follow the instructions below:

1. Press the Start/Pause button to pause the washing.
2. Press Program button for more than 3 seconds the machine will be in program selection mode.
3. Press the Program button to select the desired program.
4. Press the Start/Pause button, after 1 seconds, the dishwasher will start.

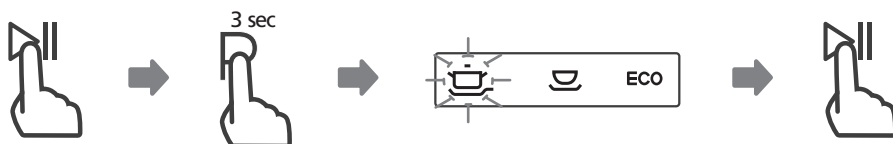



## Forget To Add A Dish?

A forgotten dish can be added any time before the detergent dispenser opens. If this is the case, follow the instructions below:

1. Press the Start/Pause button to pause the washing.
2. Wait 5 seconds then open the door.
3. Add the forgotten dishes.
4. Close the door.
5. Press the Start/Pause button after 10 seconds, the dishwasher will start.

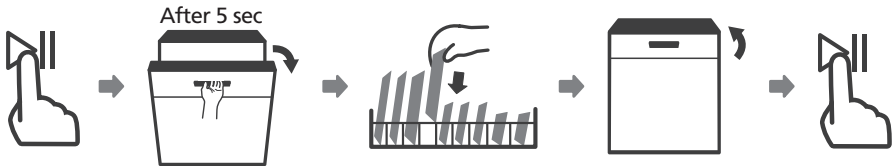

### **⚠ WARNING**



It is dangerous to open the door mid-cycle, as hot steam may scald you.

# ERROR CODES

If there is a malfunction the dishwasher will display an error code. The following table shows possible error codes and their causes.

Codes	Meanings	Possible Causes
E1	Longer inlet time.	Faucets is not opened, or water intake is restricted, or water pressure is too low.
E3	Not reaching required temperature.	Malfunction of heating element.
E4	Overflow.	Some element of dishwasher leaks.
Ed	Failure of communication between main <b>circuit board</b> with display <b>circuit board</b> .	Open circuit or break wiring for the communication.

## ⚠ WARNING

- If overflow occurs, turn off the main water supply before calling a service.
- If there is water in the base pan because of an overflow or small leak, the water should be removed before restarting the dishwasher.
- **If there is an error code that cannot be solved, please request professional assistance.**

# TECHNICAL INFORMATION

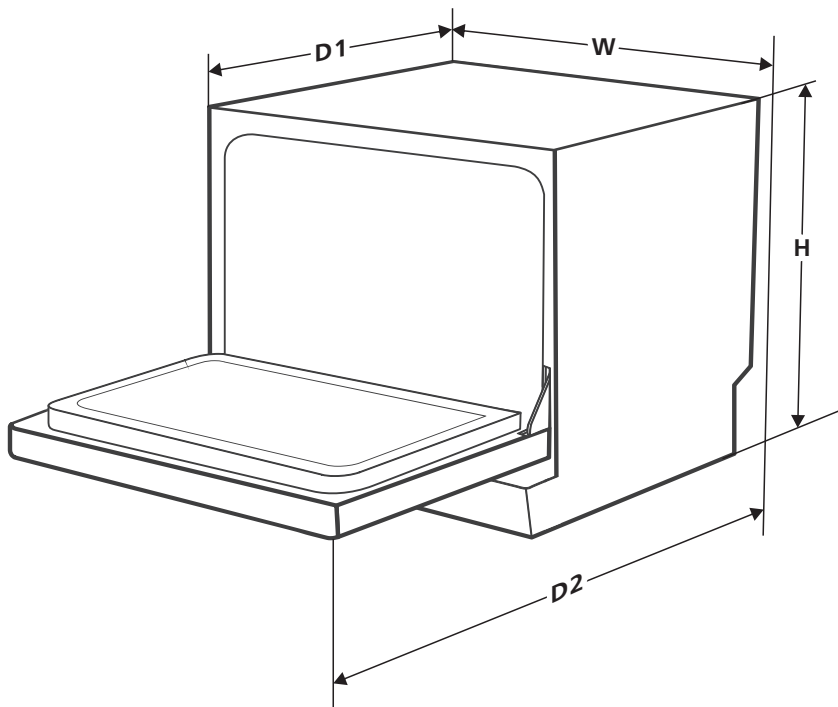

<b>Height (H)</b>	438mm
<b>Width (W)</b>	550mm
<b>Depth (D1)</b>	500mm (with the door closed)
<b>Depth (D2)</b>	812mm (with the door opened 90° )

## Product information sheet(EN 60436)

**Supplier's name or trade mark:** KONCAR

**Supplier's address (b):** Slavonska avenija 16, 10 000 Zagreb, Hrvatska

**Model identifier:** PP55TBMD6

### General product parameters:

Parameter	Value	Parameter	Value	
Rated capacity (a) (ps)	6	Dimensions in cm	Height	44
			Width	55
			Depth	50
EEI (a)	61,9	Energy efficiency class (a)	F (c)	
Cleaning performance index (a)	1,125	Drying performance index (a)	1,065	
Energy consumption in kWh [per cycle], based on the eco programme using cold water fill. Actual energy consumption will depend on how the appliance is used.	0,613	Water consumption in litres [per cycle], based on the eco program. Actual water consumption will depend on how the appliance is used and on the hardness of the water.	6,5	
Program duration (a) (h:min)	3:50	Type	Free standing	
Airborne acoustical noise emissions (a) (dB(A) re 1 pW)	49	Airborne acoustical noise emission class (a)	C (c)	
Off-mode (W)	0,49	Standby mode (W)	N/A	
Delay start (W) (if applicable)	1,00	Networked standby (W) (if applicable)	N/A	

**Minimum duration of the guarantee offered by the supplier (b):** 60 months

### Additional information:

Weblink to the supplier's website, where the information in point 6 of Annex II to Commission Regulation (EU) 2019/2022 (1) (b) is found: [www.koncar-ka.hr](http://www.koncar-ka.hr)

(a) for the eco program.

(b) changes to these items shall not be considered relevant for the purposes of paragraph 4 of Article 4 of Regulation (EU) 2017/1369.

(c) if the product database automatically generates the definitive content of this cell the supplier shall not enter these data.

(1) Commission Regulation (EU) 2019/2022 of 1 October 2019 laying down eco design requirements for household dishwashers pursuant to Directive 2009/125/EC of the European Parliament and of the Council amending Commission Regulation (EC) No 1275/2008 and repealing Commission Regulation (EU) No 1016/2010 (see page 267 of this Official Journal).

**KONČAR**