

HR

UPUTE ZA UPORABU

EN

OWNER'S MANUAL

**PERILICA RUBLJA
WASHING MACHINE**

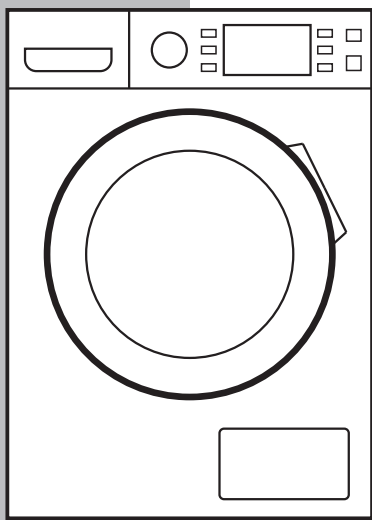

**PR147MD3INV
PR148MD3INV**

KONČAR

ŠTOVANI KUPCI,

zahvaljujemo Vam na povjerenju koje ste nam ukazali kupnjom našeg proizvoda.



Za Vaše lakše snalaženje prilikom uporabe aparata, pripremili smo ove Upute za uporabu.

Molimo Vas da pažljivo pročitate ove "Upute za uporabu" jer ćete na taj način izbjeći greške, povećati uporabno trajanje aparata, štedjeti energiju i novac.

Upute su dostupne na web adresi: **www.koncar-ka.hr**

Upute za uporabu odložite na sigurno mjesto kako bi ih mogli koristiti i za buduće potrebe. Ako aparat prodate ili ustupite drugom vlasniku tada uz aparat priložite i ove upute.



POZOR! VRUĆA POVRŠINA!



POZOR! OPASNOST OD POŽARA!

U uputama za uporabu mogu biti opisani različiti tipovi aparata koji se međusobno razlikuju po opremljenosti i načinu rada, te su zbog toga uključena i neka poglavlja, crteži i podaci koji za Vaš aparat ne dolaze u obzir.

Pridržavamo pravo izmjena i grešaka u uputama za uporabu.

Tehničke specifikacije i ovaj priručnik podložni su promjenama bez prethodne obavijesti ili najave.

SADRŽAJ

UVOD

- 3 Važne opće informacije
- 3 Informacije o jamstvu
- 5 Sigurnosna upozorenja

POSTAVLJANJE I PRIKLJUČENJE APARATA

- 13 Opis proizvoda
- 14 Postavljanje i priključenje

UPORABA APARATA

- 16 Brze upute
- 18 Prije svakog pranja
- 19 Ladica za deterdžent
- 21 Upravljački elementi i njihova uporaba
- 22 Tablica programa
- 26 Dodaci

ODRŽAVANJE APARATA

- 30 Čišćenje i održavanje
- 33 Problemi te njihovo moguće uklanjanje
- 34 Tehnički podaci

Važne opće informacije

Ovaj aparat je namijenjen isključivo za uporabu u domaćinstvu i nije namijenjen uporabi u profesionalne (komercijalne) svrhe ili namjene koje nadilaze uobičajenu uporabu u domaćinstvu.

Ako se aparat ipak tako upotrebljava, tada proizvođač ne snosi nikakvu odgovornost, a jamstvo ne vrijedi.

Proizvođač ne snosi nikakvu odgovornost za ozljede ili oštećenja izazvana nepravilnim postavljanjem ili uporabom te ne priznaje pravo na jamstvo u slučaju nepridržavanja uputa za uporabu i nesavjesne uporabe aparata.

Proizvođač zadržava pravo promijeniti konstrukciju, mjere i težinu ako to smatra potrebnim radi poboljšanja kvalitete proizvoda, bez ugrožavanja osnovnih svojstava proizvoda i bez prethodne najave.

U uputama za uporabu mogu biti opisani različiti tipovi aparata koji se međusobno razlikuju po opremljenosti i načinu rada, te su zbog toga uključena i neka poglavlja, podaci i crteži koja za Vaš aparat ne dolaze u obzir.

Informacije o jamstvu

Ako do nekog kvara na aparatu dođe tijekom jamstvene dobi, nemojte ga popravljati sami.

Reklamaciju odmah prijavite na jedno od servisnih mjesta jer u suprotnom može doći do većeg oštećenja aparata, za što proizvođač neće preuzeti nikakvu odgovornost.

Pri podnošenju reklamacije držite se teksta

Jamstvenog Lista. Najnovije informacije o servisnim mjestima nalaze se na web stranici [**www.koncar-ka.hr**](http://www.koncar-ka.hr)

Bez predaje pravilno popunjenog Jamstvenog lista i priloženog računa za kupljeni aparat reklamacija je nevažeća.

ODLAGANJE PROIZVODA

Ovi proizvodi su razvijeni i proizvedeni uz uporabu kvalitetnih materijala i komponenti koje je moguće reciklirati i ponovo iskoristiti. Simbol s lijeve strane znači da se električni i elektronički aparati na kraju njihova uporabnog vijeka ne smiju odbacivati zajedno s ostalim kućnim otpadom.



Molimo da ovaj aparat predate lokalnoj tvrtki koja se bavi zbrinjavanjem otpada ili ga odnosi u reciklažno dvorište. Ovaj aparat zadovoljava EU direktivu u svezi zbrinjavanja električnog i elektroničkog otpada.

Korisnik ne smije rastavljati aparat ili ostale komponente. Taj posao obavlja ovlaštena tvrtka koja se bavi recikliranjem takve vrste otpada.

Ambalaža je izrađena tako da ne ugrožava okoliš; ambalažni materijal je ekološki i može se preraditi, odnosno reciklirati. Nije dozvoljeno odlagati ambalažni materijal s ostalim kućnim otpadom, nego ga je potrebno odložiti na zato namjenjenom mjestu. Recikliranjem ambalaže štedi se na sirovinama i smanjuje količina industrijskog i kućanskog otpada.

SIGURNOSNA UPOZORENJA

NE RABITE APARAT PRIJE NEGO PROČITATE UPUTE ZA UPORABU I UPOZNATE SE S NJEGOVOU UPORABOM.



Upute za uporabu odložite na sigurno mjesto kako bi ih mogli koristiti i za buduće potrebe. Ako aparat prodate ili ustupite drugom vlasniku tada uz aparat priložite i ove upute.

Zbog Vaše sigurnosti, morate se pridržavati naputaka u ovim uputama te na taj način smanjiti rizike od požara, eksplozija, elekričnog udara, oštećenja imovine, opasnosti po okoliš, ozljedama osoba s ozbiljnim ili tragičnim (smrtnim) posljedicama.

⚠ POZORNOST!

Ova kombinacija simbola i riječi označava potencijalno opasnu situaciju koja može rezultirati opasnim ozljedama osoba, oštećenjem imovine, opasnosti po okoliš, te tragične (smrtne) posljedice.

POZORNOST! Proizvođač/distributer ne preuzima nikakvu odgovornost za oštećenja nastala prilikom uporabe neuzemljenog aparata, te u svezi bilo kakvog oštećenja i povreda ako se ne pridržava uputa za uporabu, u slučaju nesavjesne i nepravilne uporabe aparata, samostalnih popravaka i modifikacija te uporabe dijelova koji nisu originalni i odobreni od proizvođača.

Ako do nekog kvara na aparatu dođe, nemojte ga popravljati sami, nego kvar odmah prijavite na jedno od servisnih mjesta, jer u suprotnom može doći do većeg oštećenja aparata.

Ovaj aparat je namijenjen isključivo za uporabu u domaćinstvu i unutar zatvorenih prostora, te nije namijenjen uporabi u profesionalne (komercijalne) svrhe ili namjene koje nadilaze uobičajenu uporabu u domaćinstvu.

Ako se aparat ipak tako upotrebljava, tada proizvođač ne snosi nikakvu odgovornost, a jamstvo ne vrijedi.

⚠ POZORNOST! SIGURNOST DJECE!

⚠ POZORNOST! Po primitku aparata, raspakirajte ga, ambalažni materijal (plastičnu foliju, stiropor, drvo...) uklonite izvan domašaja djece kako se djeca ne bi ozljedila (progutala manje komade ili se ugušila plastičnom folijom).

⚠ OPREZ! Ambalažni materijal (plastična folija, stiropor, drvo...) je opasan za djecu. Djeci nemojte dozvoliti igranje ambalažnim materijalom, kako ne bi progutala manje komade ili se ugušila plastičnom folijom.

⚠ POZORNOST! Ovaj aparat mogu upotrebljavati djeca u dobi od osam godina i starija te osobe sa smanjenim tjelesnim, osjetnim ili duševnim sposobnostima ili pomanjkanjem iskustva i znanja ako dobiju nadzor ili uputu o uporabi aparata na siguran način te razumiju uključene opasnosti.

⚠ POZORNOST! Djeci onemogućite penjanje na aparat ili ulaz u bubanj jer postoji opasnost sa tragičnim posljedicama.

⚠ POZORNOST! Omekšivače rublja, deterdžente i slične proizvode držite izvan dohvata djece.

⚠ POZORNOST! Ne ostavljajte djecu bez stalnog nadzora u blizini aparata.

⚠ POZORNOST! Djeca ne smiju koristiti aparat za igru.

⚠ POZORNOST! Čišćenje i korisničko održavanje ne smiju obavljati djeca bez nadzora. Isto vrijedi i za maloljetne osobe.

Ovaj aparat nije namijenjen osobama (uključujući djecu) koje imaju smanjene fizičke, osjetne ili mentalne sposobnosti, kao i osobama koje nisu dovoljno iskusne i informirane, osim ako ih se nadgleda ili ako su dobile upute o uporabi aparata od osobe odgovorne za njihovu sigurnost.

Kućni ljubimci moraju biti pod stalnim nadzorom te im se mora onemogućiti penjanje po aparatu, zavlčenje u isti, kao i griženje kablova. Prije uporabe aparata obavite provjeru!

⚠ POZORNOST! OPASNOST OD OPEKLINA!

Površina vrata, stakla, cijev za odvod vode te dijelovi aparata mogu biti jako vrući tijekom rada pa stoga može doći do opekline. Zbog toga djeca i kućni ljubimci moraju biti udaljeni od aparata te pod stalnim nadzorom.

**⚠ POZORNOST!
OPASNOST OD ELEKTRIČNOG UDARA!**

Električna sigurnost aparata zajamčena je jedino ako je ono ispravno spojeno na ispravnu i propisnu električnu instalaciju s uzemljenjem.

Aparat obvezatno mora biti uzemljen!

Budite uvjereni kako priključni vod nije oštećen, prignječen ili zapetljan tijekom instalacije, ne zatežite priključni vod.

Ne uključujte aparat u električnu instalaciju ako je priključni vod oštećen.

Oštećeni priključni vod mora biti zamijenjen ispravnim, a smije ga zamijeniti jedino stručna osoba ili serviser.

Nestručno priključenje i popravci mogu uzrokovati električni udar i tjelesne ozljede.

Aparat se priključuje na propisno instaliranu zidnu priključnicu s kontaktom za uzemljenje s vlastitim strujnim krugom i osiguračem. Zidna priključnica mora biti uzemljena, lako pristupačna, ne smije biti izložena toplinskom zračenju i vlazi.

Priključnica i instalacija mora izdržati struju koja je uvijek veća od one potrebne za aparat.

Aparat nije dozvoljeno priključiti na električnu instalaciju preko produžnih kablova i/ili vanjskih timera ili sličnih uređaja i daljinskih kontrolera.

Ne dodirujte aparat mokrim rukama dok je uključen u električnu instalaciju te nemojte biti bos i dok se služite aparatom.

Nakon uporabe aparata, obvezatno ga odspojite od električne mreže (povlačeći utikač iz utičnice, ali samo suhim rukama) te zatvorite dovod vode.

⚠ POZORNOST! OPASNOST OD EKSPLOZIJE!

Aparat se ne smije koristiti u prostorijama gdje se pojavljuju zapaljive i/ili eksplozivne pare ili kemikalije.

Ne smije se prati ili sušiti rublje koje je čišćeno, namočeno, prano ili trljano zapaljivim ili eksplozivnim sredstvima koja su ostala na rublju (kao što su trikloretilen, benzin, aceton, vosak, ulje, odmašćivači, petrolej, itd.) jer bi moglo doći do požara ili eksplozije.

Ispušni zrak iz aparata ne smije biti usmjeren u kuhinjsku napu ili na odvod zraka koji koriste kućanski aparati na plin ili druga goriva.

**Aparat se ne smije koristiti ako se industrijske kemikalije koriste za čišćenje rublja.
Nije dozvoljeno držati zapaljive tvari u blizini ili na aparatu jer bi se mogle zapaliti.**

POZORNOST U SVEZI S POSTAVLJANJEM APARATA

Priključak za vodu i struju mora biti izveden prema nacionalnim propisima i sigurnosnim odredbama, te od strane ovlaštenog, stručnog i kvalificiranog osoblja.

Potrebno je ukloniti sve transportne blokade prije uporabe aparata jer može doći do ozbiljnih oštećenja.

Aparat je namjenjen samo za unutarnju uporabu.

Aparat nije ugradbeni, niti je predviđen za ugradnju u elemente.

Aparat ne smije biti instaliran iza prepreka (npr vrata, klizna vrata i sl.) jer se time onemogućuje potpuno otvaranje vrata na aparatu.

Aparat se ne smije postaviti u prostorijama koje su zaparene, vrlo vlažne (npr. kupaona) ili gdje se pojavljuju zapaljive, eksplozivne ili korozivne pare.

Aparat se ne smije postavljati na tepih ili podne obloge kako se ne be zaklonili ili zatvorili otvori na aparatu.

Opasnost od smrzavanja! Ne postavljajte aparat u prostorijama gdje može doći do smrzavanja ili na temperaturama blizu nule. Pri tome može doći do smrzavanja vode u pumpi, crijevima, bubnju, itd.

Aparat ne koristite pri temperaturama nižim od 5°C.

Priključci aparata (voda, odvod, struja) moraju biti dostupni nakon postavljanja.

Za priključak na vodu potrebno je koristiti novo crijevo koje je isporučeno uz aparat, a ne staro ili prije upotrebljavano crijevo. Crijevo se priključuje samo na hladnu vodu tlaka od min. 0,1 MPa do max. 1 MPa.

Crijeva za priključak na vodu i odvod moraju biti dobro pričvršćena i osigurana, te neoštećena, inače bi moglo doći do procurivanja vode.

POZORNOST U SVEZI NEPRAVILNE UPORABE

Aparat je namjenjen samo za uporabu u kućanstvu te za pranje-sušenje tekstila koji je prikladan za strojno pranje-sušenje.

Nije dozvoljeno penjati se, sjediti ili stavljati teške predmete na gornju ploču aparata.

Nije dozvoljeno naslanjati se na vrata aparata.

Ne izlažite aparat sunčevom zračenju.

Aparat se ne smije pomicati tijekom rada ili održavanja.

Ne vadite utičnicu iz utikača potezanjem priključnog voda. Nemojte presavijati ni oštećivati priključni vod, te ga nemjote uključivati - isključivati mokrim rukama.

Nemojte deinstalirati i instalirati aparat bez uputa ili nadzora.

Nije dozvoljeno prati tepihe.

Ne čistite aparat mlazom vode ili visokotlačnim parnim aparatom za čišćenje.

Ne stavljajte u perilicu više rublja od preporučenog.

Držite se maksimalnog dozvoljenog kapaciteta.

Nemojte zatvarati vrata prejakom silom. Ako se vrata teško zatvaraju, potrebno je provjeriti da li odjeća spriječava zatvaranje ili je uklještena u šarnir vrata.

Ako se aparat premješta na drugo mjesto (lokaciju), tada je potrebno:

- 1. Ponovno instalirati transportne blokade (od strane kvalificirane osobe).**
- 2. Isprazniti zaostalu vodu iz bubnja.**
- 3. Pažljivo prenositi aparat. Nikada ga ne podizati držeći za ručku ili vrata ili druge dijelove.**
- 4. Aparat je težak te ga treba pažljivo prenositi.**

POZORNOST U SVEZI UPORABE APARATA

Prije uprabe aparata preporučuje se kalibracija istoga, kako bi bolje radio (ako je ta opcija ugrađena).

Ako se aparat koristi po prvi put, potrebno je izvršiti jedan ciklus pranja bez odjeće.

Rabite samo odgovarajuće deterdžente i omekšivače koji su namjenjeni za strojno pranje rublja, a u skladu s uputama proizvođača dotičnih sredstava.

Zabranjeno je korištenje zapaljivih, eksplozivnih i štetnih otapala (benzin, alkohol, itd) umjesto deterdženta.

Provjerite da u džepovima odjeće, koju stavljate u aparat, nema kakvih predmeta (upaljači, mobiteli, igle, novčići, šibice, vijci, itd.) jer bi mogli oštetiti aparat.

Provjerite da li je voda u bubnju ispražnjena prije otvaranja vrata. Ako je voda u bubnju tada nije dozvoljeno otvaranje vrata.

Obratite pozornost i ne dodirujte odvodno crijevo tijekom pražnjenja vruće vode jer bi se mogli opeći.

Ne otvarajte filter pumpe ako je voda u aparatu jer može isteći velika količina, a voda može biti i vruća pa postoji opasnost od opekline.

Ne pokušavajte otvarati vrata na silu. Nakon završetka programa potrebno je pričekati do dvije minute kako bi se mogla otvoriti vrata.

Nije dozvoljeno ručno nadopunjavanje vode tijekom pranja.

Prostorija u kojoj se nalazi aparat mora se dobro provjetravati kako bi se spriječio povratni tok plinova koje ispuštaju aparati koji izgaraju plin i ostale energente (npr. peći, štednjaci i sl.).

Aparati čija se vrata mogu otvoriti tijekom pražnjenja vode, potrebno je pričekati oko 15 sekundi dok se ne završi proces pražnjenja vode.

Rublje koji sadrže lateks i gumene dijelove, kape za kupanje i tuširanje, rublje od vodonepropusnih tkanina, rublje, jastuci ili prevlake s spužvastom gumom, zabranjeno je sušiti u aparatu.

Rublje koje je bilo natopljeno zapaljivim ili kemijskim sredstvima (ulje, alkohol, benzin, aceton, vosak, ulje, odstranjivači mrlja, terpentini, petroleji) mora biti suho pa onda oprano u vrućoj vodi s više deterdženta, a tek se onda može sušiti u aparatu.

Nije dozvoljeno sušenje neopranog rublja.

Završni dio ciklusa pranja-sušenja izvršava se bez topline (ciklus hlađenja) kako bi rublje ostalo na temperaturi koja ga neće oštetiti.

POZOR! Nikada ne zaustavljajte aparat prije kraja programa, a ako se to mora tada rublje treba brzo izvaditi i rasprostrjeti kako bi se ohladilo. Rublje u bubnju je vruće i potreban je oprez prilikom vađenja jer može doći do opekline.

Nakon završetka programa i uporabe, potrebno je isključiti aparat, izvaditi utičnicu priključnog kabela iz električnog priključka te zatvoriti dovod vode.

Prije svakog čišćenja i održavanja, aparat obvezatno isključite iz električne mreže povlačeći utikač iz utičnice, ali samo suhim rukama!

POZORNOST U SVEZI POPLAVE

Poduzmite odgovarajuće mjere za sprječavanje proklizavanja cijevi na umivaoniku, jer snaga vode koja prolazi kroz cijev, koja nije postavljena na odgovarajući način, može pomaknuti cijev. Cijev mora biti učvršćena. Postavite čep umivaonika tako da ne zatvara odvod umivaonika.

Provjerite priključke na vodu i odvod, jer ako nisu dobro učvršćeni i osigurani, može doći do curenja vode.

POSTAVLJANJE I PRIKLJUČENJE

Opis proizvoda

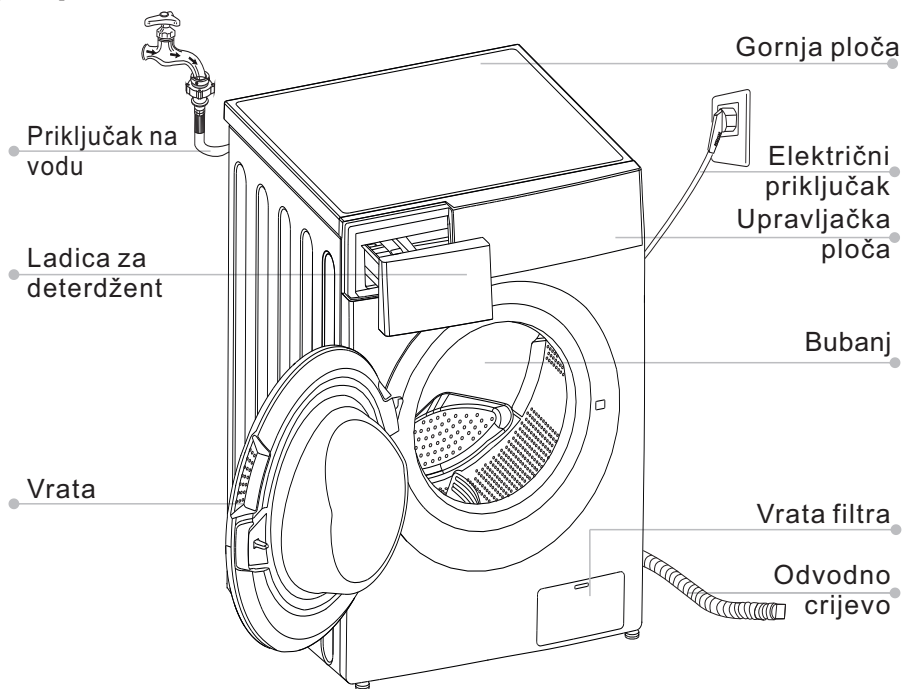

Prikazani crteži su samo informativne naravi i mogu se razlikovati od stvarnog proizvoda. Neki dijelovi mogu biti opcija i ne moraju biti uključeni u proizvod. U uputama za uporabu mogu biti opisani različiti tipovi aparata koji se međusobno razlikuju po opremljenosti i načinu rada, te su zbog toga uključena i neka poglavlja, podaci i crteži koja za Vaš aparat ne dolaze u obzir.

Pribor

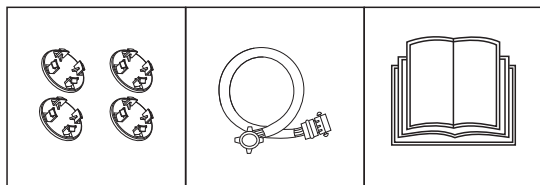

Poklopci za transportne otvore

Crijevo za priključak na hladnu vodu

Upute za uporabu

Postavljanje i priključenje

Mjesto postavljanja

⚠ Pozornost!

Stabilnost je vrlo važna kako bi se spriječilo pomicanje aparata tijekom rada (uslijed vibracija). Aparat mora stajati stabilno i biti niveliran.

Prizrite kako aparat ne bi prignječio električni vod. Obratite pažnju na minimalnu udaljenosti od zidova (prema slici)

Prije postavljanja i priključenja aparata odaberite odgovarajući prostor s karakteristikama:

1. Suha, čvrsta i ravna podloga
2. Spriječiti direktno izlaganje sunčanim zrakama
3. Odgovarajuće prozračan ili ventiliran prostor
4. Temperatura prostora mora biti iznad 0°C
5. Aparat mora udaljen od izvora topline kao što su plin, drva/ugljen i slično.

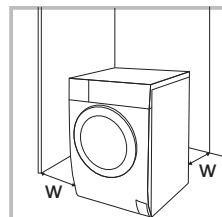

Udaljenost do zidova
 $W \geq 20\text{mm}$

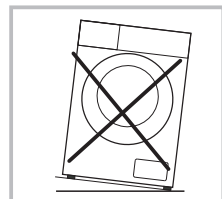

Otpakiravanje aparata

⚠ Pozornost!

Ambalažni materijal (plastičnu foliju, stiropor, drvo...) uklonite izvan domašaja djece kako se djeca ne bi ozljedila ili ugušila.

1. Uklonite kartonsku kutiju i stiroporne umetke.
2. Podignite aparat i uklonite stiropornu bazu na kojoj aparat stoji. Obvezatno uklonite stiroporni umetak (u obliku trokuta) iz donjeg dijela aparata (a) (ako je potrebno tada nagnite aparat i izvadite umetak).
3. Uklonite ljepljive trake koje učvršćuju priključni vod i odvodno crijevo.
4. Izvadite crijevo za dovod vode iz bubnja (i ostale predmete ako su unutra).

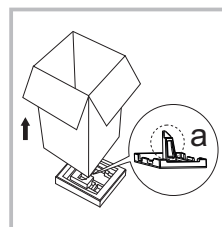

Uklanjanje transportnih blokada (vijaka)

⚠ Pozornost!

Obvezatno uklonite transportne blokade (vijke) sa stražnje strane aparata prije njegove uporabe, te ih spremite na sigurno mjesto. Transportni vijci su opet potrebni ako postavljate aparat na drugo mjesto.



Olabavite 4 vijka pomoću odgovarajućeg ključa te ih odvijte.

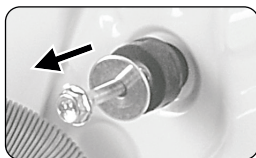

Izvučite vijke i gumene dijelove iz otvora, te ih spremite na sigurno.

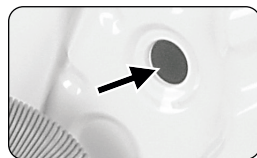

Pokrijte 4 otvora s poklopcima iz pribora.

Niveliranje aparata

⚠ Pozornost!

Sve četiri matice na nožicama moraju biti čvrsto pritegnute uz dno kućišta aparata.

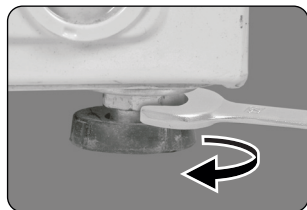

1. Olabavite sigurnosnu maticu.
2. Odvrćite odgovarajuću nožicu dok ne dođe u kontakt s podom.
3. Postavite libelu na gornju ploču aparata, te okretanjem nožica podesite ravninu. Nožice osigurajte pritezanjem sigurnosne matice ključem.

Aparat mora stajati stabilno i nivelirano na tvrdom podu. **NE POSTAVLJAJTE NIŠTA ISPOD NOŽICA** (komadiće drveta, pločice is slično).

Priključak aparata na vodu

⚠ Pozornost!

Obratite pozornost i pratite upute kako ne bi došlo do curenja vode i mogući nastanak štete. Nije dozvoljeno uvijanje, gnječenje, modificiranje ili rezanje crijeva za priključak na vodu.



Priključite crijevo za dovod vode na priključak za ulaz vode na stražnjem dijelu aparata, a drugi kraj crijeva priključite na pipu za hladnu vodu. Čvrsto zategnite plastične matice.



NAPOMENA !

Priključite manualno, i dobro zategnite matice bez uporabe alata. Provjeriti jesu li priključci sigurni i čvrsti, te da li propuštaju vodu.

Odvod vode (odvodno crijevo)

⚠ Pozornost!

Obratite pozornost i pravilno postavite odvodno crijevo. U suprotnom može doći do curenja vode i oštećenja. Nije dozvoljeno savijanje ili produžavanje odvodnog crijeva.

Moguća su dva načina postavljanja izlaznog kraja odvodnog crijeva:

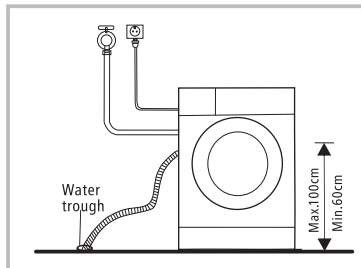

1. Umetnuti kraj crijeva u izljevni otvor i osigurati od vađenja.

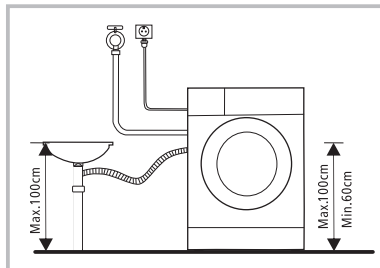

2. Umetnuti kraj crijeva u T-komad na odvodnoj cijevi umivaonika.

UPORABA APARATA

Brze upute

⚠ Pozornost!

Aparat mora biti propisno postavljen i priključen.

Ako se aparat koristi prvi put tada je potrebno proći cijelu proceduru pranja ali bez odjeće i detrdženta, koristeći program Pamuk 90°C.

Kalibracija aparata (ako je ugrađena, ovisno o modelu)

Aparat ima mogućnost detekcije težine rublja, čime se optimizira rad i svojstva zbog smanjenja potrošnje vode i energije.

Iz tog razloga se preporučuje kalibracija aparata, kako bi ostvario bolja svojstva.

1. Isprazniti bubanj.
2. Priključiti aparat na električnu energiju.
3. Uključiti aparat (tipka 0/I), te istovremeno pritisnuti tipke "Odgoda" i "Centrifuga" u trajanju od 10 sekundi, dok se na displayu ne prikaže "t19".
4. Pritisnuti "Start/Pauza" za start aparata te pričekati dok display ne prikaže "*****".

1. Prije početka pranja

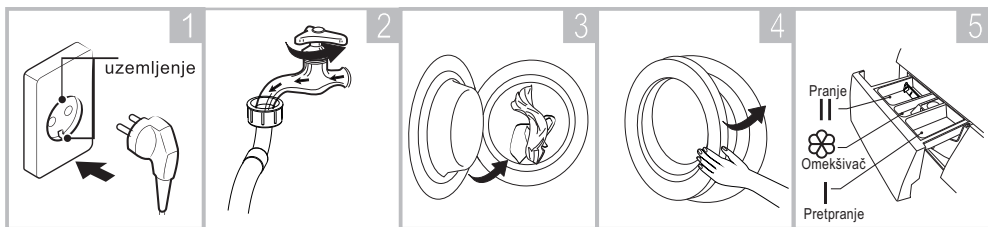

Priključiti na
el. mrežu

Otvoriti pipac
za dovod vode

Punjenje bubnja
rubljem

Zatvoriti
vrata

Dodati
deterđent

NAPOMENA!

Deterđent se dodaje u odjeljak "I" samo u slučaju ako se odabere pretpranje (ako aparat ima tu funkciju).

2. Pranje

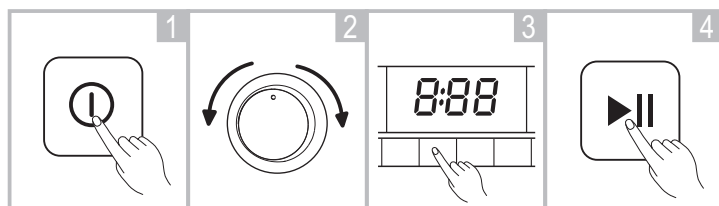

Uključiti
aparat

Odabrati
program

Odabrati
funkciju
ili osnovno

Pokrenuti program
na tipku
"Start/Pauza"

NAPOMENE!

Ako je odabrano osnovno pranje tada se korak 3 može i preskočiti. Izgled crteža je samo informativne naravi kako bi se pokazala procedura.

3. Nakon pranja

Javlja se zvučni signal ili se na displayu ispisuje poruka "End" (OVISNO O MODELU). Pričekati da se vrata otključaju, te izvaditi rublje. Isključiti aparat iz električne mreže i zatvoriti dovod vode.

Prije svakog pranja

Radni uvjeti predviđeni za aparat trebali bi biti između 5-40°C. Aparat se ne smije koristiti na temperaturama ispod 0°C jer može doći do smrzavanja te oštećenja ulaznog ventila, crijeva i pumpe. Ako se aparat nalazi na tako niskoj temperaturi, tada ga je potrebno postaviti u prostor s normalnom temperaturom, a to će osigurati da ne dođe do smrzavanja prije uporabe.

Obvezatno provjeriti podatke o deterdžentu koji će se koristiti u pranju.

Koristiti deterdžente koji se malo ili nimalo pjene, a prikladni su za strojno pranje rublja.

Obvezatno provjeriti etikete na odjevnim predmetima o vrsti tkanine, načinu pranja, najvišoj temperaturi pranja i ostalim svojstvima.

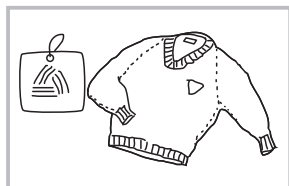

Provjeriti etikete
na rublju

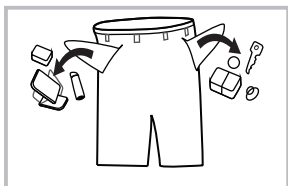

Izvaditi predmete
iz džepova

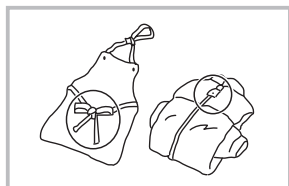

Zavezati vezice te
zatvoriti patent zatvarače

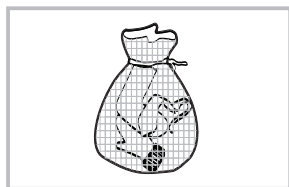

Staviti malenu ili vrlo
osjetljivu odjeću u
specijalne vreće za pranje

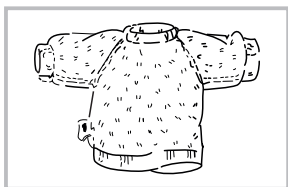

Naopako izvrnuti odjeću
kojoj strše dugi konci ili
otpada materijal (mucice)

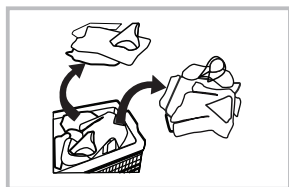

Odvojiti i složiti odjeću
prema vrstama tkanine

⚠ Pozornost!

Ako se pere vrlo mala količina odjeće (1 komad), može doći do većeg ekscentriciteta te drmanja i lupanja, čime se uključuje signal za veliku nebalansiranost. Zato je preporučljivo da se doda još odjeće kako bi se postigla bolja uravnoteženost tijekom pranja.

Nije dozvoljeno pranje odjeće koja je natopljena zapaljivim materijalima (benzin, petrolej, nafta, alkohol i ostalo.) Ovo je već prije opisano.

Ladica za deterdžent

- I Odjeljak za deterdžent za pretpranje
- II Odjeljak za deterdžent za pranje
- ☼ Odjeljak za omekšivač
- ☉ Poluga za oslobađanje ladice kako bi se mogla kompletno izvaditi van.

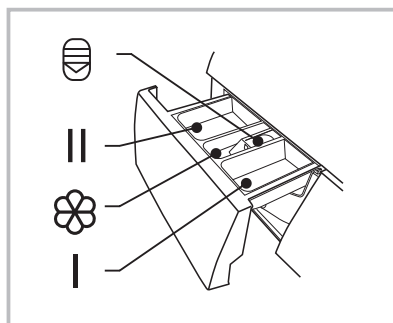

NAPOMENA!

Deterdžent se dodaje u odjeljak "I" samo u slučaju ako se odabere pretpranje (ako aparat ima tu funkciju).

| Program | I | II | ☼ | Program | I | II | ☼ |
|-----------------------------|---|----|---|------------|---|----|---|
| Pamuk | ○ | ● | ○ | Intenzivno | | ● | ○ |
| Sintetika | ○ | ● | ○ | ECO 40-60 | | ● | ○ |
| Sterilizacija | ● | ● | ○ | Osjetljivo | | ● | ○ |
| Traper | ○ | ● | ○ | Vuna | | ● | ○ |
| Mješovito | ○ | ● | ○ | Sport | ○ | ● | ○ |
| 20°C | | ● | ○ | Brzo 45' | ○ | ● | ○ |
| Ispiranje i centrifugiranje | | | ○ | Brzo 15' | | ● | ○ |
| Centrifugiranje | | | | | | | |

● Obvezatno

○ Po želji (opcija)

Uporaba deterdženta

| Preporuka za uporabu deterdženta za pranje | Ciklus pranja (program) | Temp. pranja | Vrsta rublja ili tekstila |
|---|--|---------------------------|--|
| Snažni deterdženti sa sredstvima za izbjeljivanje | Pamuk, ECO 40-60 Mješovito, Traper, Intenzivno | 20/30/ 40/60°C | Rublje od bijele pamučne ili lanene tkanine otporne na visoke temperature pranja |
| Color deterdženti (za pranje obojenih tkanina), bez sredstva za izbjeljivanje | Pamuk, ECO 40-60 Mješovito, Traper, Intenzivno | hladno/ 20/30/ 40°C | Obojeno (šareno) rublje od pamučne ili lanene tkanine |
| Color ili blagi deterdženti bez sredstva za izbjeljivanje | Sintetika | hladno/ 20/30/ 40°C | Obojeno (šareno) rublje od sintetike ili tkanina koje se lako održavaju |
| Blagi deterdženti za pranje | Sintetika | 20/30°C | Osjetljive tkanine, svila, viskoza |
| Specijalni deterdženti za vunu | Vuna | 20/30°C | Vuna |

NAPOMENE!

Ako se koriste granulasti ili vrlo gusti i ljepljivi deterdženti ili aditivi, prije njihovog stavljanja u odjeljak, potrebno ih je razrijediti s vodom kako bi se spriječilo začepljivanje izlaza iz odjeljka a time i preljevanje vode iz ladice kada aparat uzima vodu.

Potrebno je odabrati odgovarajući deterdžent za odgovarajuću temperaturu pranja kako bi se postigle najbolje performanse pranja uz manju potrošnju energije i vode.

Kako bi se ostvarila najbolja čistoća rublja, važno je odgovarajuće doziranje deterdženta.

Potrebno je smanjiti količinu deterdženta ako bubanj nije potpuno napunjen. Neophodno je podesiti količinu deterdženta prema tvrdoći vode (ako je voda iz vodovoda meka, tada treba manje deterdženta).

Doziranje deterdženta ovisi o nivou zaprljanosti, jer manje zaprljano rublje zahtjeva manju količinu deterdženta.

Visoko koncentrirani (kompaktni) deterdženti zahtjevaju pažljivo i točno doziranje.

Pojava jakog pjenjenja i loši rezultati pranja i ispiranja, posljedice su prevelike količine deterdženta.

Ako je oprano rublje sivo ili ako se pojavljuje gomilanje ostataka (mucica) na bubnju, grijačem elementu i rublju, to je posljedica premalene količine deterdženta.

Upravljački elementi i njihova uporaba

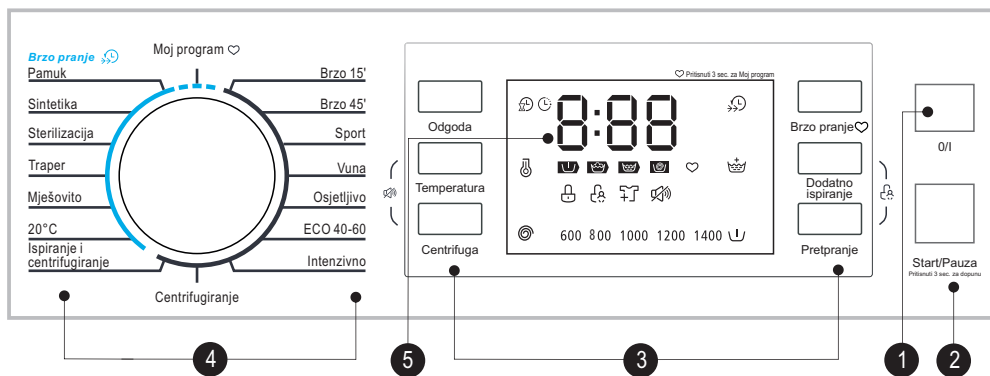

NAPOMENE!

Crteži i skice samo su informativne naravi i može se razlikovati od stvarnog izgleda na aparatu.

Programi s simbolom  mogu se odabrati s funkcijom za brzo pranje.

- | | |
|--|---|
| <p>1 O / I</p> <p>Tipka za uključenje/isključenje aparata.</p> | <p>2 Start/Pauza</p> <p>Tipka za pokretanje ili pauziranje ciklusa pranja.</p> |
| <p>3 Dodaci</p> <p>Tipka za odabir dodatnih funkcija čiji će se simbol pojaviti na displayu.</p> | <p>4 Programi</p> <p>Držak za odabir raznih programa prema vrsti rublja.</p> |
| <p>5 Display (pokazivač)</p> <p>Display (pokazivač) pokazuje postavke, funkcije, procijenjeno preostalo vrijeme te statusne poruke na aparatu. Display će svjetliti tijekom ciklusa pranja/sušenja.</p> | |

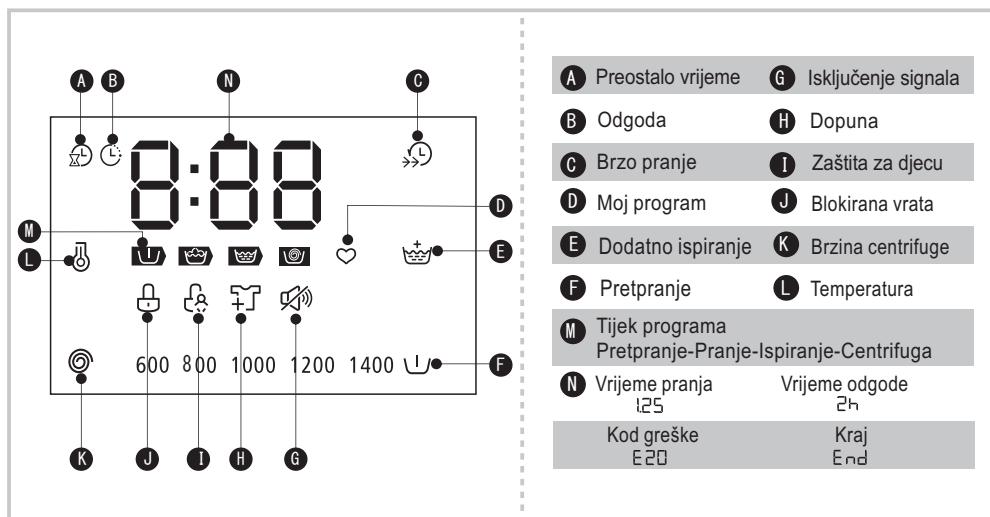

Tablica programa

| Program | Kapacitet (kg) | | Vrijeme trajanja (h:mm) | |
|-----------------------------|----------------|-------------|-------------------------|-------------|
| | PR147MD3INV | PR148MD3INV | PR147MD3INV | PR148MD3INV |
| Pamuk | 7.0 | 8.0 | 2:59 | 2:59 |
| Sintetika | 3.5 | 4.0 | 2:45 | 2:45 |
| Sterilizacija | 3.5 | 4.0 | 2:30 | 2:30 |
| Traper | 7.0 | 8.0 | 1:45 | 1:45 |
| Mješovito | 7.0 | 8.0 | 0:58 | 0:58 |
| 20°C | 3.5 | 4.0 | 1:01 | 1:01 |
| Ispiranje i centrifugiranje | 7.0 | 8.0 | 0:20 | 0:20 |
| Centrifugiranje | 7.0 | 8.0 | 0:12 | 0:12 |
| Intenzivno | 7.0 | 8.0 | 3:48 | 3:48 |
| ECO 40-60 | 7.0 | 8.0 | 3:13 | 3:32 |
| Osjetljivo | 2.0 | 2.0 | 0:50 | 0:50 |
| Vuna | 2.0 | 2.0 | 1:07 | 1:07 |
| Sport | 3.5 | 4.0 | 0:45 | 0:45 |
| Brzo 45' | 2.0 | 2.0 | 0:45 | 0:45 |
| Brzo 15' | 2.0 | 2.0 | 0:15 | 0:15 |

Napomena !

Podaci u tablicama samo su informativne naravi. Stvarni parametri mogu odstupati od parametara prikazanih u tablicama. Vrijednosti trajanja programa, potrošnje energije i vode mogu se razlikovati u ovisnosti od opterećenja i vrste rublja, odabranih dodatnih funkcija, tipa vode, odabranog deterdženta i temperature okoliša. Stvarni parametri ovise o tome kako će se aparat koristiti. Tablicu uzeti samo kao približni orijentir.

POZORNOST !

U slučaju nestanka električne energije tijekom rada aparata, zadnje postavke programa su memorirane, pa nakon povratka električne energije, program nastavlja s radom. Kod nekih modela je potrebno pritisnuti tipku "0/1" kako bi program nastavio s radom.

| Program | Kapacitet (kg) PR147MD3INV | Temperatura (°C) | Vrijeme trajanja (hh:mm) | Potrošnja energije (kW/ciklus) | Potrošnja vode (litara/ciklus) | Najviša temperatura (°C) (1) | Preostala vlaga (%/brzina centrifuge) (2) |
|------------------|-------------------------------|------------------|-----------------------------|-----------------------------------|-----------------------------------|------------------------------------|---|
| 20°C | 3.5 | 20 | 1:01 | 0,177 | 41 | 20 | 65/1000 |
| Pamuk | 7.0 | 60 | 3:14 | 1.340 | 65 | 60 | 53/1400 |
| Intenzivno | 7.0 | 40 | 3:48 | 0.955 | 65 | 40 | 70/800 |
| Mješovito | 7.0 | 40 | 0:58 | 0,657 | 65 | 40 | 70/800 |
| Brzo 15' | 2.0 | Hladno | 0:15 | 0,030 | 31 | Hladno | 75/800 |
| ECO 40-60 (3) | 7.0 | - | 3:28 | 0,775 | 54 | 36 | 53/1400 |
| | 3.5 | - | 2:42 | 0,470 | 44 | 34 | 53/1400 |
| | 2.0 | - | 2:42 | 0,200 | 35 | 21 | 53/1400 |

Napomena !

Podaci u tablicama samo su informativne naravi. Stvarni parametri mogu odstupati od parametara prikazanih u tablicama. Stvarni parametri ovise o tome kako će se aparat koristiti. Tablicu uzeti samo kao približni orijentir.

Vrijednosti za programe različite od "ECO 40-60" jesu samo za informaciju.

U skladu s Regulativom (EU) 2019/2023, energetska učinkovitost jest B.

Programi za testiranje energije: ECO 40-60. Ostale postavke su osnovne.

Polu punjenja za 7.0kg aparat iznosi 3.5kg.

Četvrtina punjenja za 7.0kg aparat iznosi 2.0kg.

- 1) Najviša postignuta temperatura rublja u ciklusu pranja koje traje najmanje 5 min.
- 2) Preostala vlaga nakon ciklusa pranja u vodi, sadrži postotak i broj okretaja centrifuge pri kojoj je ta vrijednost doegnuta.
- 3) Program ECO40-60 omogućuje pranje normalno zaprljanog pamučnog rublja, koje je perivo od 40°C ili 60°C, zajedno u istom ciklusu. Ovaj se program koristi unutar regulative (EU) 2019/2023.

Programi sa najvećom učinkovitosti glede potrošnje energije jesu općenito oni koji se izvode duže vremena pri nižim temperaturama.

Punjenje rubljem, perilice rublja za kućanstvo, na kapacitet koji odgovara odgovarajućem programu doprinosi uštedi energije i vode.

Razina buke i preostala vlaga su ovisne o brzini vrtnje centrifuge. Veća brzina vrtnje rezultira većom razinom buke, ali manjom preostalom vlagom.

| Program | Kapacitet (kg) PR148MD3INV | Temperatura (°C) | Vrijeme trajanja (hh:mm) | Potrošnja energije (kW/ciklus) | Potrošnja vode (litara/ciklus) | Najviša temperatura (°C) (1) | Preostala vlaga (%/brzina centrifuge) (2) |
|------------------|-------------------------------|------------------|-----------------------------|-----------------------------------|-----------------------------------|------------------------------------|---|
| 20°C | 4.0 | 20 | 1:01 | 0,183 | 44 | 20 | 65/1000 |
| Pamuk | 8.0 | 60 | 3:14 | 1.445 | 71 | 60 | 53/1400 |
| Intenzivno | 8.0 | 40 | 3:48 | 1.013 | 71 | 40 | 70/800 |
| Mješovito | 8.0 | 40 | 0:58 | 0,716 | 71 | 40 | 70/800 |
| Brzo 15' | 2.0 | Hladno | 0:15 | 0,030 | 31 | Hladno | 75/800 |
| ECO 40-60 (3) | 8.0 | - | 3:38 | 0,857 | 59 | 34 | 53/1400 |
| | 4.0 | - | 2:48 | 0,504 | 46 | 29 | 53/1400 |
| | 2.0 | - | 2:48 | 0,24 | 37 | 21 | 53/1400 |

Napomena !

Podaci u tablicama samo su informativne naravi. Stvarni parametri mogu odstupati od parametara prikazanih u tablicama. Stvarni parametri ovise o tome kako će se aparat koristiti. Tablicu uzeti samo kao približni orijentir.

Vrijednosti za programe različite od "ECO 40-60" jesu samo za informaciju.

U skladu s Regulativom (EU) 2019/2023, energetska učinkovitost jest B.

Programi za testiranje energije: ECO 40-60. Ostale postavke su osnovne.

Polu punjenja za 8.0kg aparat iznosi 4.0kg.

Četvrtina punjenja za 8.0kg aparat iznosi 2.0kg.

- 1) Najviša postignuta temperatura rublja u ciklusu pranja koje traje najmanje 5 min.
- 2) Preostala vlaga nakon ciklusa pranja u vodi, sadrži postotak i broj okretaja centrifuge pri kojoj je ta vrijednost doegnuta.
- 3) Program ECO40-60 omogućuje pranje normalno zaprljanog pamučnog rublja, koje je perivo od 40°C ili 60°C, zajedno u istom ciklusu. Ovaj se program koristi unutar regulative (EU) 2019/2023.

Programi sa najvećom učinkovitosti glede potrošnje energije jesu općenito oni koji se izvode duže vremena pri nižim temperaturama.

Punjenje rubljem, perilice rublja za kućanstvo, na kapacitet koji odgovara odgovarajućem programu doprinosi uštedi energije i vode.

Razina buke i preostala vlaga su ovisne o brzini vrtnje centrifuge. Veća brzina vrtnje rezultira većom razinom buke, ali manjom preostalom vlagom.

Tablica programa

Programi koji su dostupni prema vrsti rublja.

| Programi | |
|-----------------------------|--|
| Pamuk | Pamučne i lanene tkanine otporne na više temperature. |
| Sintetika | Pranje rublja od sintetičkih tkanina. Majice, jakne, miješano. Tijekom pranja pletenih tkanina potrebno je smanjiti količinu deterdženta zbog slabije konstitucije vlakana i jačeg stvaranja pjene. |
| Sterilizacija | Održava se temperatura iznad 60°C u trajanju dužem od 30 minuta. Efektivno uklanjanje štetnih bakterija. |
| Traper | Specijalno za pranje odjeće od traper (jeans-a). |
| Mješovito | Zajedničko pranje odjeće od pamučnih i sintetičkih tkanina. |
| 20°C | Osnovna temperatura od 20°C. Pranje u hladnoj vodi. |
| Ispiranje i centrifugiranje | Dodatno ispiranje i centrifugiranje. |
| Centrifugiranje | Samo centrifugiranje s odabranom brzinom vrtnje. |
| Intenzivno | Kako bi se pojačao efekt pranja, produžuje se vrijeme istog. |
| ECO 40-60 | Pranje navlaka za poplun i slično. Osnovna temperatura od 40°C, prikladno za pranje rublja na 40°C - 60°C. |
| Osjetljivo | Namjenjeno pranju osjetljivih tkanina kao što je svila, saten, sintetička vlakna, kao i mješane tkanine. |
| Vuna | Pranje vunениh tkanina za ručno ili strojno pranje, kao i od tkanina s većim sadržajem vune. Vrlo nježan program pranja kojim se sprječava skupljanje, duže su pauze u programu (pa su tkanine duže u vodi). |
| Sport | Pranje odjeće namjenjene za sport i aktivnosti. |
| Brzo 45' | Brzo pranje manje količine odjeće, koja nije jako zaprljana. |
| Brzo 15' | Kratak program za brzo pranje odjeće. Prikladno za lagano zaprljano rublje kao i za malu količinu rublja. |

Dodaci

| Program | Osnovna temperatura (°C) | Osnovna brzina centrifuge (okr/min) | Dodatne funkcije |
|-----------------------------|--------------------------|-------------------------------------|------------------|
| Brzo 15' | Hladno | 800 | |
| Brzo 45' | 40 | 800 | |
| Sport | 20 | 800 | |
| Vuna | 40 | 600 | |
| Osjetljivo | 30 | 600 | |
| ECO 40-60 | - | 1400 | |
| Intenzivno | 40 | 800 | |
| Centrifugiranje | - | 1000 | |
| Ispiranje i centrifugiranje | - | 1000 | |
| 20°C | 20 | 1000 | |
| Mješovito | 40 | 800 | |
| Traper | 60 | 800 | |
| Sterilizacija | - | 800 | |
| Sintetika | 40 | 1200 | |
| Pamuk | 40 | 1400 | |

Odgoda

Brzo pranje

Dodatno ispiranje

Pretpranje

Napomena !

Za maksimalne brzine vrtnje, trajanje programa te ostale detalje oko programa "ECO 40-60" i "Pranje i Sušenje", potrebno je konzultirati informacijski list. Tablica prikazuje koju funkcije moguće na kojem programu.

Dodaci

Odgoda

Odgoda

Podešavanje funkcije odgode:

1. Odabrati program
2. Pritisnuti tipku "Odgoda" kako bi se odabralo vrijeme (od 0-24 sata) nakon kojeg će se aparat uključiti i započeti zadani program
3. Pritisnuti tipku "Start/Pauza" za potvrdu funkcije



Odabrati
program



Podesiti vrijeme
odgode



Start

Poništenje funkcije odgode:

Pritiskati tipku "Odgoda" dok se na displayu ne pojavi 0H. Ovo treba napraviti prije nego što se program pokrene. Ako je već program u tijeku, tada je potrebno pritisnuti tipku "0/I" kako bi se program poništio.

POZORNOST !

U slučaju nestanka električne energije tijekom rada aparata, zadnje postavke programa su memorirane, pa nakon povratka električne energije, program nastavlja s radom. Kod nekih modela je potrebno pritisnuti tipku "0/I" kako bi program nastavio s radom.

Pretpiranje

Pretpiranje

Pretpiranje je funkcija koja omogućuje dodatno pranje rublja prije početka glavnog programa pranja, a pogodna je za pranje prašnjavog i jako prljavog rublja. Potrebno je umetnuti deterdžent u odjeljak "I".

Dodatno ispiranje

Dodatno ispiranje

Funkcija kojom se rublje podvrgava dodatnom ispiranju.

Brzo pranje

Brzo pranje

Funkcija kojom se skraćuje vrijeme pranja.



Moj program

Ova funkcija definira i memorira Vaš omiljen program koji često koristite. Nakon odabira programa i dodataka, pritisnite i držite tipku " Brzo pranje ♥" oko 3 sekunde, prije nego započne pranje, a Vaš omiljeni program biti će snimljen (memoriran). Tvornički je postavljen program "Pamuk".



Dopuna (dodavanje rublja)

Ova se funkcija može uključiti tijekom izvršavanja programa. Dok se bubanj vrti i dok je u njemu velika količina vode i visoka temperatura tada nije uputno niti sigurno niti moguće nasilno otvoriti vrata.

Pritisnuti tipku "Start/Pauza" i držati 3 sekunde kako bi se dodalo rublje tijekom procesa pranja. Nakon toga slijediti ove korake:

1. Pričekati da se bubanj prestane vrtiti.
2. Pričekati da se mehanizam vrata otključa kako bi se mogla otvoriti.
3. Dodati rublje, zatvoriti vrata te pritisnuti tipku "Start/Pauza".



Pritisnuti tipku
"Start/Pauza" na 3 sekunde

Dodati rublje

Start

Pozornost!

Nije dozvoljeno koristiti funkciju "Dopuna" ako nivo vode u bubnju prelazi donji rub ili ako je viša temperatura (razljevanje vode, opekline od vruće vode).

Ostale funkcije

Temperatura

Temperatura

Pritiskanjem tipke odabire se temperatura (Hladno (cold) ,20°C, 30°C, 40°C,60°C,90°C).

Centrifuga

Centrifuga

Pritiskanjem tipke odabire se brzina centrifuge:
0 - 600 - 800 - 1000 - 1200 - 1400 o/min



Roditeljsko zaključavanje (zaštita za djecu)

Aparat posjeduje posebnu funkciju za sigurnost djece, a kojim se onemogućuju nehотиčni pritisci na tipke koji mogu uzrokovati pogrešano djelovanje aparata.

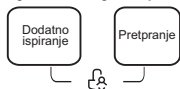

Pritisnuti tipke "Dodatno ispiranje" i "Pretrpanje" 3 sec. dok se ne javi zvučni signal

Pozornost!

Kada je funkcija aktivirana i program se starta, upali se simbol zaštite za djecu, te se na displayu trepere preostalo vrijeme i simbol zaštite za djecu. Pritiskom na bilo koju tipku uzrokuje treperenje simbola zaštite za djecu u trajanju od 3 sekunde. Nakon što program završi, na displayu će se izmjenjivati "END" i simbol zaštite za djecu u trajanju od 10 sekundi, a nakon toga će simbol zaštite za djecu dodatno svjetliti još 3 sekunde.

Pritiskom obje tipke na 3 sekundi, funkcija se poništava.

Roditeljsko zaključavanje blokira sve tipke osim "0/1" i "Roditeljsko zaključavanje".

Prekidom električne energije, funkcija se poništava, ali na nekim modelima aparata ta funkcija ostaje aktivna i nakon povratka električne energije (ovisno o modelu).

Funkciju zaštite za djecu potrebno je poništiti prije odabira programa i početka pranja.



Isključenje zvučnog signala



Odaberi program



Pritisnuti tipke "Centrifuga" i "Temperatura" te držati 3 sekunde za isključenje zvučnog signala.

Za uključenje zvučnog signala pritisnuti iste tipke i držati 3 sekunde. Postavke će biti zapamćene do slijedećeg reseta.

Pozornost!

Nakon isključenja zvučne funkcije, zvukovi se neće moći aktivirati.

ODRŽAVANJE APARATA

Čišćenje i održavanje

⚠ Pozornost!

Prije početka održavanja, potrebno je isključiti aparat iz električne mreže te zatvoriti dovod vode.

Čišćenje kućišta aparata

Odgovarajuće održavanje aparata može produžiti radni vijek aparata. Površine se mogu čistiti krpom umočenom u mješavinu vode i tekućeg deterdženta. deterdžent mora biti neutralan i ne smije biti abrazivan. Ako se uoči procurivanje vode po površini tada je treba odmah obrisati krpom. Nije dozvoljena uporaba oštrih i šiljatih predmeta u svrhu čišćenja.

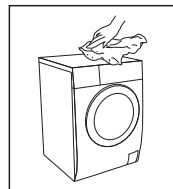

Napomena !

Uporaba kemijskih ili sličnih sredstava (alkohol, kemijska sredstva, otapala, kiseline, ili slično) nije dozvoljeno u svrhu čišćenja.

Čišćenje bubnja

Preostala hrđa unutar bubnja, koja je preostala od metalnih predmeta, mora odmah biti uklonjena pomoću deterdženata koji ne sadrže klor. Uporaba metalne vune nije dozvoljeno u svrhu čišćenja.

Napomena !

Ne stavljati rublje u aparat tijekom čišćenja bubnja.

Čišćenje stakla i brtve vrata

Staklo vrata potrebno je obrisati suhom krpom nakon svakog pranja. Tako će se ukloniti sva nečistoća i nakupine. U suprotnom će doći do akumuliranja nakupina što može uzrokovati procurivanje.

Ukloniti sve objekte (novčići, gumbi, i sl.) iz brtvi nakon svakog pranja.

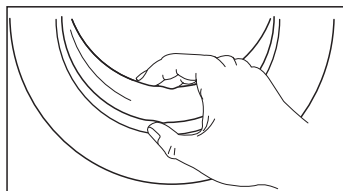

Čišćenje filtra za ulaz vode

Napomena !

Ulazni filtar se mora očistiti ako je dotok vode u aparat smanjen.

Čišćenje filtra za priključak na pipu:

1. Zatvoriti pipu za vodu.
2. Odspojiti crijevo za ulaz vode.
3. Očistiti filtar pomoću četkice i vode.
4. Ponovno spojiti crijevo na pipu.

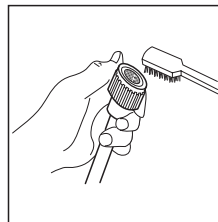
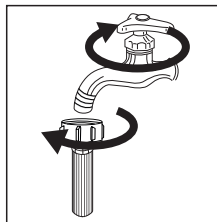

Čišćenje filtra za ulaz vode na aparatu:

1. Odvrnuti ulazni fitting sa crijevom na stražnjoj strani aparata.
2. Izvući filtar pomoću odgovarajućeg alata (kliješta s dugačkim vrhom).
3. Očistiti filtar pomoću četkice i vode.
4. Ponovo pričvrstiti fitting za dovod vode na stražnjoj strani aparata.

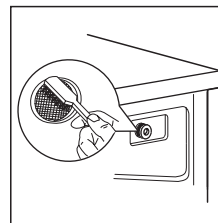
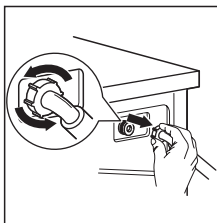

Čišćenje ladice za deterdžent

1. Pritisnuti prema dolje strelicu na pokrovu za omekšivač koji se nalazi unutar ladice.
2. Podići kopču prema gore i izvaditi pokrov omekšivača te vodom sve isprati, a naročito žljebove.
3. Vratiti pokrov za omekšivač te gurnuti ladicu na mjesto.

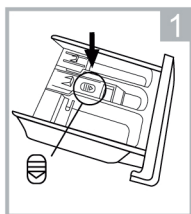

1 Pritisnuti polugicu te izvući ladicu van

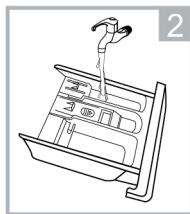

2 Oprati ladicu ispod mlaza tekuće vode

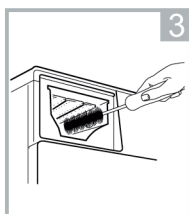

3 Očistiti komoru za ladicu na aparatu pomoću četkice

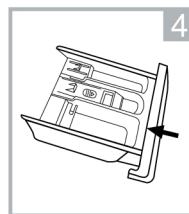

4 Vratiti ladicu natrag u aparat

Napomena !

Uporaba kemijskih ili sličnih sredstava (alkohol, kemijska sredstva, otapala, kiseline, ili slično) nije dozvoljeno u svrhu čišćenja.

Čišćenje filtra na pumpi za odvod vode

⚠ Pozornost!

Obratiti pozornost na vruću vodu koja može preostati nakon pranja. Zbog toga je potrebno pričekati kako bi se smjesa otpadne vode i deterdženta ohladila. Prije početka čišćenja, potrebno je isključiti aparat iz električne mreže (opasnost od električnog udara) te zatvoriti dovod vode.

Filtar za odvod vode može zaustaviti nakupine konca i tkanine (kuglice) te male predmete tijekom pranja kako ne bi ušli u pumpu te je oštetili.

Filtar treba redovito čistiti kako bi se osigurao normalan rad aparata.

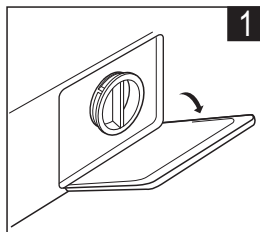

Otvoriti vrata za pristup filtru

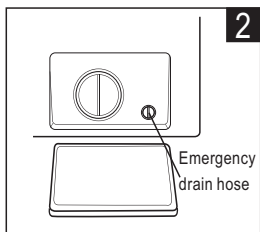

Okrenuti za 90° te povući prema van maleno pomoćno crijevo te otvoriti poklopac na izlazu iz crijeva

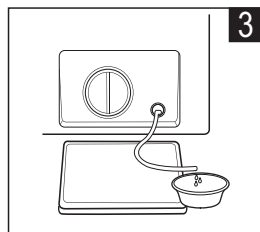

Nakon što sav višak vode istekne (u pripremljenu posudu), pokrite otvor i vratite crijevo na mjesto

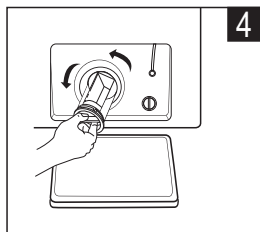

Otvoriti poklopac s filtrom okretanjem obrnuto od smjera kazaljke na satu

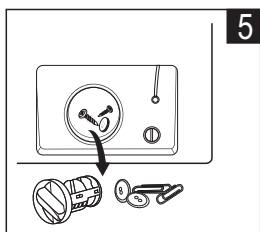

Izbaciti strane objekte i ostatke

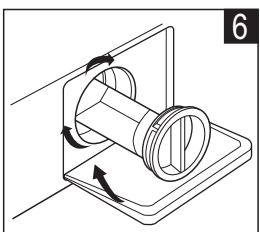

Vratiti filtara na mjesto i zatvoriti ga, te zatvoriti vrata za pristup

Pozornost!

Obratiti pozornost i uvjerite se kako je otvor na malenom pomoćnom crijevu dobro zatvoren pomoću poklopca te crijevo vraćeno na mjesto, jer bi u protivnom moglo doći do curenja vode.

Ovisno o modelu, neki aparati nemaju pomoćno odvodno crijevo pa se prema tome korak 2 i korak 3 može preskočiti. Nakon okretanja i vađenja poklopca s filtrom, voda će direktno istjecati iz komore pa je treba prihvatiti u neku posudu.

Tijekom izvođenja odgovarajućeg programa, u pumpi može biti vruće vode.

Nije dozvoljeno otvaranje poklopca s filtrom tijekom rada aparata, nego tek kada se program kompletno izvrši, aparat ohladi, te isključiti.

Uvjerite se kako je poklopac dobro pritegnut i siguran.

Problemi te njihovo moguće uklanjanje

POZORNOST!

Samo stručno osposobljeno servisno osoblje, iz ovlaštenog servisa, smije obavljati popravke.



Ukoliko Vaš aparat ne radi ispravno, uzrok bi mogla biti neka sitnica.

Kako biste uštedijeli vrijeme i novac prije pozivanja servisera, provjerite sljedeće:

| Opis | Razlog | Moguće rješenje |
|--|--|---|
| Aparat se ne može startati | Vrata aparata nisu zatvorena | Zatvoriti vrata i ponovo startati aparat Provjeriti da li se zaglavila odjeća |
| Vrata aparata se ne mogu otvoriti | Sigurnosna brava na vratima je uključena | Isključiti aparat sa električne mreže te ponovno startati aparat |
| Curenje vode | Priključak dovoda vode ili ispusta vode nije stegnut | Provjeriti i pritegnuti priključak na vodu Očistiti crijevo za ispušt vode |
| Ostaci deterdženta u ladicu | Deterdžent je vlažan ili u grudicama | Očistiti, oprati i obrisati ladicu za deterdžent |
| Signalno svjetlo ili display ne svijetli | Prekid u napajanju upravljačke ploče ili spojeva | Provjeriti da li je došlo do prekida u električnoj mreži te da li je priključak pravilno priključen na električnu mrežu |
| Prevelika buka | Transportne blokade. Pod nije čvrst i ravan. | Provjeriti da li su transportne blokade uklonjene Provjeriti da li je aparat postavljen na čvrstu i ravnu podlogu te niveliran |

| Kod na displayu | Razlog | Moguće rješenje |
|-----------------|--|--|
| <i>E30</i> | Vrata aparata nisu zatvorena | Zatvoriti vrata i ponovo startati program Provjeriti da li se zaglavila odjeća |
| <i>E10</i> | Problemi s ubrizgavanjem vode tijekom pranja | Provjeriti da li je tlak vode prenizak Provjeriti da li je crijevo za ulaz vode presavijeno, prignječeno ili blokirano Provjeriti da li je filter za ulaz vode začepljen |
| <i>E21</i> | Predugo pražnjenje vode | Provjeriti da li je crijevo za izlaz vode blokirano |
| <i>E12</i> | Procurivanje vode | Ponovo startati aparat |
| <i>EXX</i> | Ostalo | Pokušati ponovo startati aparat, a ako se greška i dalje pojavljuje tada pozvati ovlaštenu servis. |

Ukoliko predložena rješenja ne uklone problem tada isključite aparat, izvadite utikač iz utičnice, zatvorite dovod vode te pozovite ovlaštenu servis.

Kolebanja u električnoj mreži:

Ponekad se događaju velike promjene napona u mreži ili čak vrlo brzi i kratki prekidi napona u mreži (dijelić sekunde ili do sekundu-dvije). Ta pojava može uzrokovati prekid rada elektronike u aparatu. U tom slučaju isključite aparat iz mreže, pričekajte nekoliko minuta, uključite aparat te ponovo pokrenite program. Ako to rješenje ne pomogne tada se obratite ovlaštenom sevisu.

Tehnički podaci

| | |
|----------------------|----------------|
| Model | PR147MD3INV |
| Standardni tlak vode | 0.05MPa~1MPa |
| MAX. struja | 10A |
| Napon | 220-240V~ 50Hz |
| Kapacitet pranja | 7.0kg |
| Dimenzije(Š*D*V) | 595*495*850mm |
| Težina | 60kg |
| Nazivna snaga | 2000W |

| | |
|----------------------|----------------|
| Model | PR148MD3INV |
| Standardni tlak vode | 0.05MPa~1MPa |
| MAX. struja | 10A |
| Napon | 220-240V~ 50Hz |
| Kapacitet pranja | 8.0kg |
| Dimenzije(Š*D*V) | 595*565*850mm |
| Težina | 68kg |
| Nazivna snaga | 2000W |

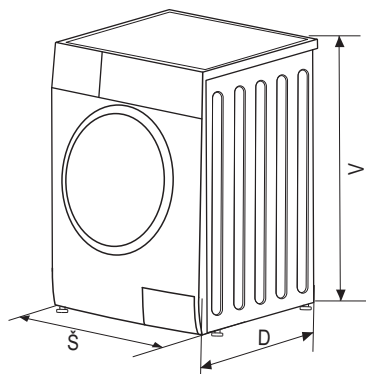

Informacije o prijevozu

Odspojiti aparat s električne mreže, zatvoriti pipu za vodu. Odspojiti crijevo za dovod i odvod vode, isprazniti vodu iz bubnja preko filtra pumpe (vidjeti poglavlje prije), očistiti aparat, provjeriti da li su zatvorena vrata bubnja i ladica za deterdžent, staviti 4 transportne blokade.

Ako je moguće, sačuvajte originalnu ambalažu i proizvod uvijek prevozite u originalnoj ambalaži. Pridržavajte se znakova i uputa za prijevoz na kutiji.

Ako nemate originalnu kutiju tada poduzmite potrebne mjere za zaštitu vanjskih površina (staklenih, plastičnih i obojenih površina) aparata od udaraca.

Aparat je težak pa ga je potrebno pažljivo prenositi i podizati. Nikada ga ne podizati držeći za ručku ili vrata ili druge dijelove.

Nakon transporta, aparat se mora ponovno postaviti i priključiti u skladu s uputama.

Informacijski list proizvoda

Ime ili zaštitni znak dobavljača: KONČAR

Adresa dobavljača (b): KONČAR - KUĆANSKI APARATI d.d. , Slavonska avenija 16 , 10000 Zagreb , Hrvatska

Identifikacijska oznaka modela: PR147MD3INV

Opći parametri proizvoda:

| Parametar | Vrijednost | | Parametar | Vrijednost | |
|---|-------------------|----|--|-------------------|----|
| Nazivni kapacitet (°)(kg) | 7,0 | | Dimenzije u cm | Visina | 85 |
| | | | | Širina | 60 |
| | | | | Dubina | 50 |
| EEL _w (°) | 59,9 | | Razred energetske učinkovitosti (°) | B | |
| Indeks učinkovitosti pranja (°) | 1,04 | | Učinkovitost ispiranja (g/kg) (°) | 5,0 | |
| Potrošnja energije u kWh po ciklusu, na temelju programa eco 40-60. Stvarna potrošnja energije ovisit će tome kako se uređaj koristi. | 0,516 | | Potrošnja vode u litrama po ciklusu, na temelju programa eco 40-60. Stvarna potrošnja vode ovisit će o tome kako se uređaj koristi i o tvrdoći vode. | 45 | |
| Najviša temperatura u obrađenom tekstilu (°) (°C) | Nazivni kapacitet | 36 | Preostali sadržaj vlage (°)() | Nazivni kapacitet | 53 |
| | Polovina | 34 | | Polovina | 53 |
| | Četvrtina | 21 | | Četvrtina | 53 |

| | | | | |
|---|-------------------|--|--|-------------|
| Brzina centrifugiranja (°)(okr./min) | Nazivni kapacitet | 1400 | Razred učinkovitosti centrifugiranja (°) | B |
| | Polovina | 1400 | | |
| | Četvrtina | 1400 | | |
| Trajanje programa (°)(h:min) | Nazivni kapacitet | 3:28 | Vrsta | samostojeći |
| | Polovina | 2:42 | | |
| | Četvrtina | 2:42 | | |
| Emisija buke koja se prenosi zrakom u fazi centrifugiranja (°)(dB(A) re 1 pW) | 76 | Razred emisije buke koja se prenosi zrakom (°)(faza centrifugiranja) | B | |
| Isključeno stanje (W) | 0,50 | Stanje pripravnosti (W) | - | |
| Odgodeni početak rada (W) (ako je primjenjivo) | 4,00 | Umreženo stanje pripravnosti (W) (ako je primjenjivo) | - | |

Minimalno trajanje jamstva koje nudi dobavljač (°): 60 mjeseci

Ovaj je proizvod projektiran za ispuštanje iona srebra tijekom ciklusa pranja

NE

Dodatne informacije:

Poveznica na internetsku stranicu dobavljača koja sadržava informacije navedene u točki 9. Priloga II. Uredbi Komisije (EU) 2019/2023 (°) (°): www.koncar-ka.hr

(°) za program eco 40-60.

(°) izmjene tih stavki ne smatraju se relevantnima za potrebe članka 4. stavka 4. Uredbe (EU) 2017/1369.

(°) ako baza podataka o proizvodima automatski generira sadržaj ove ćelije, dobavljač ne unosi te podatke.

(°) Uredba Komisije (EU) 2019/2023 od 1. listopada 2019. o utvrđivanju zahtjeva za ekološki dizajn kućanskih perilica rublja i kućanskih perilica-sušilica rublja u skladu s Direktivom 2009/125/EZ Europskog parlamenta i Vijeća, o izmjeni Uredbe Komisije (EZ) br. 1275/2008 te o stavljanju izvan snage Uredbe Komisije (EU) br. 1015/2010 (vidjeti stranicu 285 ovoga Službenog lista).

Informacijski list proizvoda

Ime ili zaštitni znak dobavljača: KONČAR

Adresa dobavljača ^(b): KONČAR - KUĆANSKI APARATI d.d. , Slavonska avenija 16 , 10000 Zagreb , Hrvatska

Identifikacijska oznaka modela: PR148MD3INV

Opći parametri proizvoda:

| Parametar | Vrijednost | | Parametar | Vrijednost | |
|---|-------------------|----|--|-------------------|----|
| Nazivni kapacitet ^(c) (kg) | 8,0 | | Dimenzije u cm | Visina | 85 |
| | | | | Širina | 60 |
| | | | | Dubina | 57 |
| EEL _w ^(e) | 60,0 | | Razred energetske učinkovitosti ^(e) | B | |
| Indeks učinkovitosti pranja ^(e) | 1,04 | | Učinkovitost ispiranja (g/kg) ^(e) | 5,0 | |
| Potrošnja energije u kWh po ciklusu, na temelju programa eco 40-60. Stvarna potrošnja energije ovisit će tome kako se uređaj koristi. | 0,545 | | Potrošnja vode u litrama po ciklusu, na temelju programa eco 40-60. Stvarna potrošnja vode ovisit će o tome kako se uređaj koristi i o tvrdoći vode. | 48 | |
| Najviša temperatura u obrađenom tekstilu ^(e) (°C) | Nazivni kapacitet | 34 | Preostali sadržaj vlage (%) () | Nazivni kapacitet | 53 |
| | Polovina | 29 | | Polovina | 53 |
| | Četvrtina | 21 | | Četvrtina | 53 |

| | | | | |
|---|-------------------|--|--|-------------|
| Brzina centrifugiranja (°)(okr./min) | Nazivni kapacitet | 1400 | Razred učinkovitosti centrifugiranja (°) | B |
| | Polovina | 1400 | | |
| | Četvrtina | 1400 | | |
| Trajanje programa (°)(h:min) | Nazivni kapacitet | 3:38 | Vrsta | samostojeći |
| | Polovina | 2:48 | | |
| | Četvrtina | 2:48 | | |
| Emisija buke koja se prenosi zrakom u fazi centrifugiranja (°)(dB(A) re 1 pW) | 76 | Razred emisije buke koja se prenosi zrakom (°)(faza centrifugiranja) | B | |
| Isključeno stanje (W) | 0,50 | Stanje pripravnosti (W) | - | |
| Odgodeni početak rada (W) (ako je primjenjivo) | 4,00 | Umreženo stanje pripravnosti (W) (ako je primjenjivo) | - | |

Minimalno trajanje jamstva koje nudi dobavljač (°): 60 mjeseci

Ovaj je proizvod projektiran za ispuštanje iona srebra tijekom ciklusa pranja

NE

Dodatne informacije:

Poveznica na internetsku stranicu dobavljača koja sadržava informacije navedene u točki 9. Priloga II. Uredbi Komisije (EU) 2019/2023 (°) (°): www.koncar-ka.hr

(°) za program eco 40-60.

(°) izmjene tih stavki ne smatraju se relevantnima za potrebe članka 4. stavka 4. Uredbe (EU) 2017/1369.

(°) ako baza podataka o proizvodima automatski generira sadržaj ove ćelije, dobavljač ne unosi te podatke.

(°) Uredba Komisije (EU) 2019/2023 od 1. listopada 2019. o utvrđivanju zahtjeva za ekološki dizajn kućanskih perilica rublja i kućanskih perilica-sušilica rublja u skladu s Direktivom 2009/125/EZ Europskog parlamenta i Vijeća, o izmjeni Uredbe Komisije (EZ) br. 1275/2008 te o stavljanju izvan snage Uredbe Komisije (EU) br. 1015/2010 (vidjeti stranicu 285 ovoga Službenog lista).

Washing Machine

OWNER'S MANUAL

Read This Manual 

Read all instructions and explanations for the installation before use. Follow the instructions carefully. Keep the operation instructions handy for later use. If the appliance is sold or passed on, ensure that the new owner always receives this operation instructions.

CONTENTS

SAFETY INSTRUCTIONS

- Safety Instructions 2

INSTALLATION

- Product Description 9
- Installation 10

OPERATION

- Quick Start 13
- Before Each Washing 15
- Detergent Dispenser 16
- Control Panel 18
- Programmes.....20
- Option..... 29

MAINTENANCE

- Cleaning and Care 33
- Trouble Shooting 36
- Technical Specifications 37
- Product Fiche 38

SAFETY INSTRUCTIONS

■ Safety Instructions

Please read the following safety information thoroughly and follow it strictly to minimize the risk of fire or explosion, electric shock and to prevent property damage, personal injury or loss of life. Failing to follow these instructions shall void any warranty.

Warning!

This combination of symbol and signal word indicates a potentially dangerous situation which may result in death or serious injuries unless it's avoided.

Caution!

This combination of symbol and signal word indicates a potentially dangerous situation which may result in slight or minor injuries or damage to property and the environment.

Note!

This combination of symbol and signal word indicates a potentially dangerous situation which may result in slight or minor injuries.

Warning!

ELECTRIC SHOCK HAZARD

- If the supply cord is damaged, it must be replaced by the manufacturer, its service agent or similarly qualified persons in order to avoid a hazard.
 - If the machine is damaged, it must not be operated unless repaired by the manufacturer, its service agent or similarly qualified persons.
- Risk of electric shock!

SAFETY INSTRUCTIONS

- The appliance can be used by children aged from 8 years and above and persons with reduced physical, sensory or mental capabilities or lack of experience and knowledge if they have been given supervision or instruction concerning use of the appliance in a safe way and understand the hazards involved. Children shall not play with the appliance. Cleaning and user maintenance shall not be made by children without supervision.
- Children should be supervised that they do not play with the appliance.
- Children 3 years and under shall be kept away from the appliance or continuously supervised.
- Animals and children may climb into the machine. Check the machine before every operation.
- Do not climb or sit on the appliance.

INSTALLATION LOCATION AND SURROUNDING

- All washing and additional substances are to be kept in a safe place out of the reach of children.
- Do not install the machine on a carpet floor. The obstruction of the openings by a carpet can damage the machine.
- Keep the appliance clear from heating sources and direct sunlight to avoid plastic and rubber parts to corrode.
- Do not use the appliance in humid environments or rooms containing explosive or caustic gas. In case of water leakage or water splashes let the appliance dry in the open air.
- The appliance must not be installed behind a lockable door, a sliding door or a door with a hinge on the opposite side to that of the washing machine.

SAFETY INSTRUCTIONS

- Do not operate the machine in rooms with a temperature of below 5°C. This can cause damages to parts of it. If it is unavoidable, make sure to drain the water completely from the appliance after every use (see "Maintenance - Cleaning of drain pump filter") to avoid damages caused by frost.
- Never use flammable sprays or substances in the immediate proximity of the appliance.

INSTALLATION

- Remove all packaging material and transport bolts before using the appliance. Otherwise, serious damage may result.
- This appliance is equipped with a single inlet valve and can be connected to the cold water supply only.
- Mains plug must be accessible after installation.
- Before washing clothes for the first time, the product shall be operated once throughout all the procedures without any clothes inside.
- Before using the washing machine, the product shall be calibrated.
- Do not put any excessively heavy objects on the appliance, like water containers or heating devices.
- The new hose-sets supplied with the appliance are to be used and that old hose-sets should not be reused.
- Max. Inlet water pressure 1 MPa. Min. inlet water pressure 0.05 MPa.

ELECTRICAL CONNECTION

- Make sure the supply cable is not trapped by the machine, it can get damaged.
- Connect the product to a grounded outlet protected by a fuse complying with the values in the "Technical specifications" table. The grounding installation has to be made by a qualified electrician. Ensure that the machine is installed in accordance with the local regulations.

SAFETY INSTRUCTIONS

•Water and electrical connections must be carried out by a qualified technician in accordance with the manufacturer's instructions and local safety regulations.

Warning!

- Don't use multiple plugs or extension cords.
- The appliance must not have an external switching device such as a timer or connected to a circuit that is regularly switched on and off.
- Do not pull the plug out of the mains outlet if there is flammable gas around.
- Never pull out power plug with wet hands.
- Always pull at the plug, not at the cable.
- Always unplug the appliance if it is not being used.

WATER CONNECTIONS

- Check the connections of the water inlet tubes, the water tap and the outlet hose for possible problems due to changes of water pressure. If the connections loosen or leak close the water tap and get it repaired. Do not use the appliance before the pipes and hoses are installed properly by qualified persons.
- Glass door may become very hot during the operation. Keep children and pets far away from the machine while it is operating.
- The water inlet and outlet hoses have to be safely installed and remain undamaged. Otherwise, water leakage can occur.
- Do not remove the drain pump filter while there is still water in the appliance. Big quantities of water can leak out, and there is a risk of scalding due to hot water.

SAFETY INSTRUCTIONS

OPERATION AND MAINTENANCE

- Never use any flammable, explosive or toxic solvents. Do not use gasoline and alcohol etc. as detergents. Only select detergents that are suitable for machine washing.
- Make sure that all pockets are emptied. Sharp and rigid items such as coins, brooches, nails, screws, stones etc. may cause serious damages to this machine.
- Remove all objects from pockets such as lighters and matches before use the appliance.
- Thoroughly rinse items that have been washed by hand.
- Items that have been soiled with substances such as cooking oil, acetone, alcohol, petrol, kerosene, spot removers, turpentine, wax and wax removers should be washed in hot with an extra amount of detergent before being dried in the appliance.
- Items containing foam rubber (latex foam), shower caps, water proof textiles, rubber backed articles and clothes or pillows fitted with foam rubber pads should not be dried in the machine
- Fabric softeners or similar products should be used as recommended in their instructions.
- Never try to open the door forcefully. The door will unlock shortly after the end of a cycle.
- Please do not close the door with excessive force. If it is found difficult to close the door, please check if the clothes are properly inserted and distributed.

SAFETY INSTRUCTIONS

- Always unplug the appliance and close the water tap before cleaning and maintenance and after each use.
- Never pour water over the appliance for cleaning purpose. Risk of electric shock!
- Repairs shall only be carried out by the manufacturer, its service agent or similarly qualified persons in order to avoid a hazard. The producer will not be responsible for damages caused by the intervention of not authorized persons.

TRANSPORT

- Before Transport:
 - Bolts shall be reinstalled to the machine by a specialized person
 - Accumulated water shall be drained out of the machine
- This appliance is heavy. Transport with care. Never hold any protruding part of the machine when lifting. The machine door cannot be used as a handle.

INTENDED USE

The product is intended only for home use and for textiles in household amounts suitable for machine washing and drying. This appliance is for indoor use only and not intended for built in use. Only use according to these instructions. The appliance is not intended for commercial use.

Any other use is considered as improper use. The producer is not responsible for any damage or injuries that may result of it.

- This appliance is intended to be used in household and similar applications such as:
 - Staff kitchen areas in shops, offices and other working environments;
 - Farm houses;
 - By clients in hotels, motels and other residential type environments;
 - Bed and breakfast type environments;
 - Areas for communal use in blocks of flats or in launderettes.

SAFETY INSTRUCTIONS

Packaging/Old appliance



This marking indicates that this product should not be disposed with other household wastes throughout the EU. To prevent possible harm to the environment or human health from uncontrolled waste disposal, recycle it responsibly to promote the sustainable reuse of material resources. To return your used device, please use the collection systems or contact the retailer where the product was purchased. They return and can take this product for environmental safe recycling.

INSTALLATION

■ Product Description

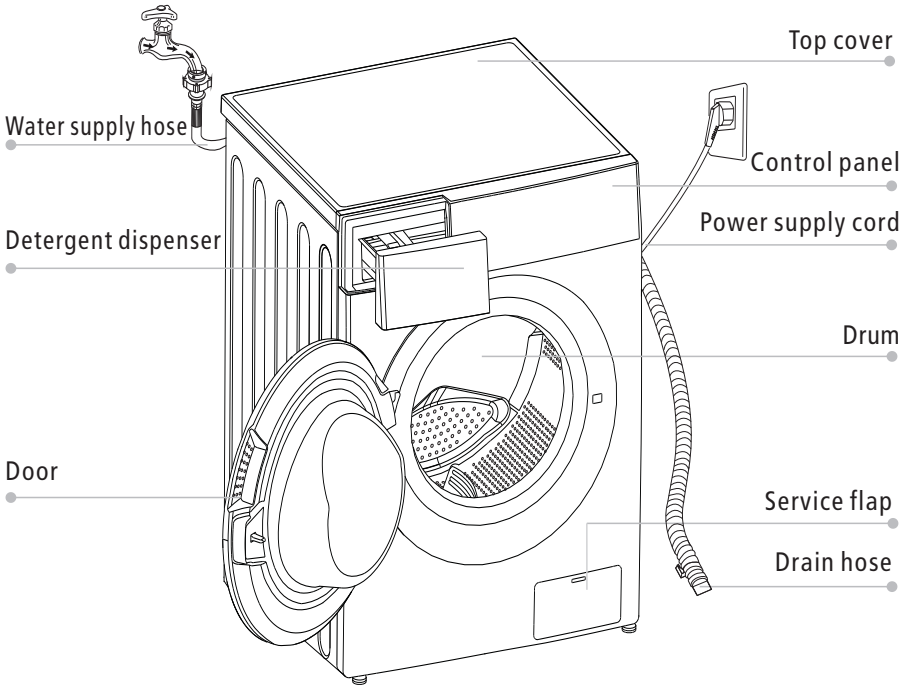

Note!

- The product picture is for illustration only, please refer to real product as reference.

Accessories

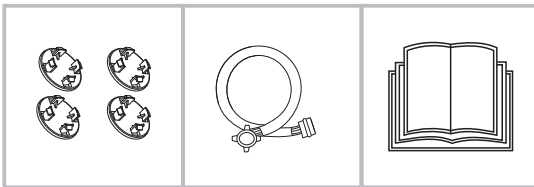

4 x Cover caps

1 x Supply hose
cold water

1 x Owner's manual

INSTALLATION

■ Installation

Installation area

⚠ Warning!

- Stability is important to prevent the product from wandering! Make sure the machine is standing leveled and stable.
- Make sure that the product does not stand onto the power cord.
- Make sure to maintain the minimum distances from the walls as shown in the picture

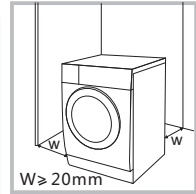

Before installing the machine, the location characterized as follows shall be selected:

1. Rigid, dry, and level surface
2. Avoid direct sunlight
3. Sufficient ventilation
4. Room temperature is above 0°C
5. Keep far away from the heat sources such as coal or gas burning appliances.

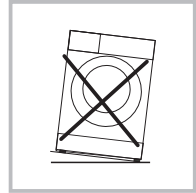

Unpacking the washing machine

⚠ Warning!

- Packaging material (e.g. Films, Styrofoam) can be dangerous for children.
- There is a risk of suffocation ! Keep all packaging well away from children.

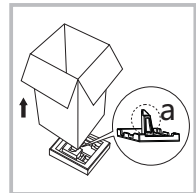

1. Remove the cardboard box and styrofoam packing.
2. Lift the washing machine and remove the base packaging. Make sure the small triangle foam (a) is removed with the bottom packaging together. If not, lay the unit down on the side surface and remove it manually.
3. Remove the tape securing the power supply cord and drain hose.
4. Remove the inlet hose from the drum.

INSTALLATION

Remove transport bolts

⚠ Warning!

- You must remove the transport bolts from the backside before using the product.



Loosen the 4 transport bolts with a spanner.

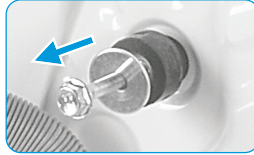

Remove the bolts including the rubber parts and keep them for future use.

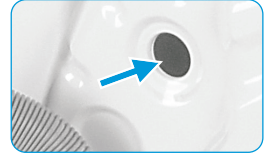

Close the holes using the cover caps.

Levelling the washing machine

⚠ Warning!

- The lock nuts on all four feet must be screwed tightly against the housing.

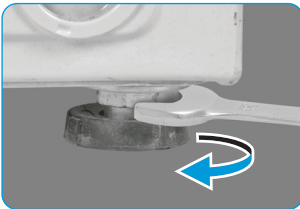

1. Loosen the lock nut.
2. Turn the foot until it reaches the floor.
3. Adjust the legs and lock the nuts with a spanner. Make sure the machine is level and steady.

Connect the water supply hose

⚠ Warning!

To prevent leakage or water damage, follow the instructions in this chapter

- Do not kink, crush or modify water inlet hose.



Connect the water supply hose to the water inlet valve and a water tap with cold water as indicated.



🔧 Note!

- Connect manually, do not use tools. Check if the connections are tight.

INSTALLATION

Drain Hose

⚠ Warning!

- Do not kink or protract the drain hose.
- Position drain hose properly ,otherwise damage might result of water leakage.

There are two ways to place the end of drain hose:

1.Put it into the water trough.

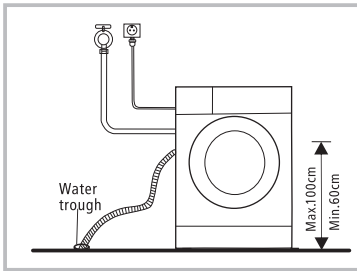

2.Connect it to the branch drain pipe of the trough.

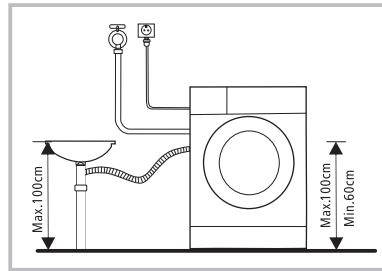

OPERATION

■ Quick Start

⚠ Caution!

- Before washing, please make sure the washing machine is installed properly.
- Your appliance was thoroughly checked before it left the factory. To remove any residual water and to neutralize potential odors, it's recommended to clean your appliance before first use. For this reason, start the Cotton program at 90°C without laundry and detergent.

📌 Calibration

It's recommended to calibrate the washing machine, so that provide the best performance.

The appliance is able to detect the amount of laundry loaded. This function is optimizing the product performance by minimizing energy and water consumption, saving you money and time. For this reason it's recommended to calibrate the appliance for best use.

- 1- Remove all accessories from the drum and close the door;
- 2- Insert the mains plug to the socket;
- 3- Switch on the washing machine and press "Delay" and "Spin" simultaneously for 10 seconds until "t19" is displayed;
- 4- Press [▷||] to start the appliance and wait till "*****" is displayed.

OPERATION

1. Before Washing

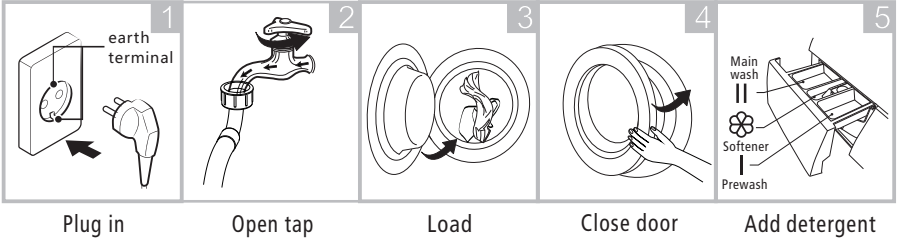

Note!

- Detergent need to be added in compartment I if the pre-wash function is selected.

2. Washing

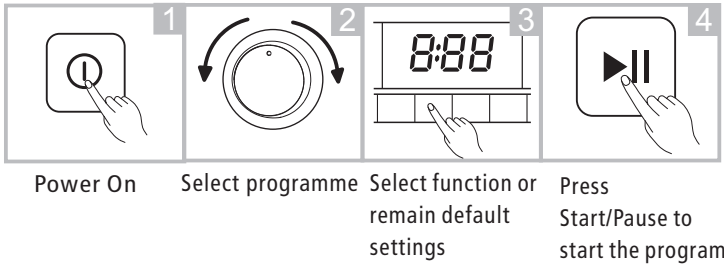

3. After Washing

Buzzer beep and "End" on display.

OPERATION

■ Before Each Washing

- The ambient temperature of the washing machine should be 5-40°C. If used under 0°C, the inlet valve and draining system may be damaged. If the machine is installed under freezing conditions, it should be transferred to normal ambient temperature to ensure the water supply hose and drain hose can unfreeze before use.
- Please check your laundry care labels and the detergent use instructions before wash. Use non-foaming or less-foaming detergent suitable for machine washing properly.

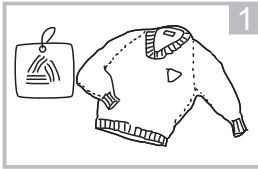

Check the care label

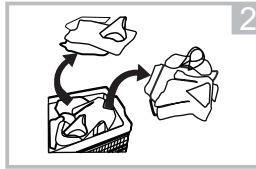

Sort laundry according to color and textile type



Take all items out of the pockets

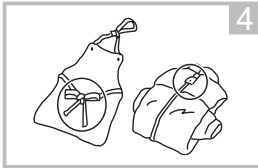

Tie together long textile strips and belts, close zips and button

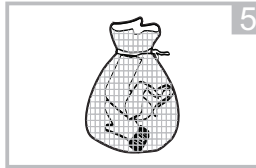

Put small items into a laundry bag

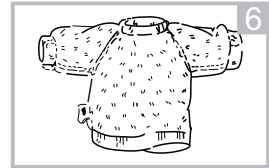

Turn easy-pilling and long-pile fabric inside out

⚠ Warning!

- Do not wash or dry articles that have been cleaned in, washed in, soaked in, or dabbed with combustible or explosive substances like wax, oil, paint, gasoline, alcohol, kerosene, and other flammable materials.
- Washing single clothes items may easily create big eccentricity and cause alarm due to unbalance. Therefore it is suggested to add one or two more laundry items to the wash so that spin can be done smoothly.

OPERATION

■ Detergent Dispenser

- I Pre wash
- II Main wash
- ☼ Softener
- ⊖ Release button to pull out the dispenser

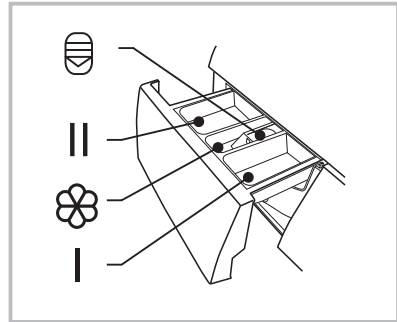

⚠ Caution!

- Detergent only need to be added in "compartment I "after selecting pre-wash function.

| Programme | I | II | ☼ | Programme | I | II | ☼ |
|---------------|---|----|---|------------|---|----|---|
| Cotton | ○ | ● | ○ | Intensive | | ● | ○ |
| Synthetic | ○ | ● | ○ | ECO 40-60 | | ● | ○ |
| Sterilization | ● | ● | ○ | Delicate | | ● | ○ |
| Jeans | ○ | ● | ○ | Wool | | ● | ○ |
| Mix | ○ | ● | ○ | Sport Wear | ○ | ● | ○ |
| 20°C | | ● | ○ | Rapid 45' | ○ | ● | ○ |
| Rinse & Spin | | | ○ | Quick 15' | | ● | ○ |
| Spin Only | | | | | | | |

OPERATION

Detergent Recommendation

| Recommended washing detergent | Wash cycles | Washing temp. | Type of laundry and textile |
|--|--|-------------------|--|
| Heavy-duty detergent with bleaching agents and optical brighteners | Cotton, ECO 40-60, Mix, Jeans, Intensive | 20/30/ 40/60 | White laundry made from boil-proof cotton or linen |
| Colour detergent without bleaching agent and optical brighteners | Cotton, ECO40-60, Mix, Jeans, Intensive | Cold/20/ 30/40 | Coloured laundry made from cotton or linen |
| Color or mild detergent without optical brighteners | Synthetic | Cold/20/ 30/40 | Coloured laundry made from easy care fibres or synthetic materials |
| Mild washing detergent | Synthetic | 20 /30 | Delicate textiles, silk, viscose |
| Special wool detergent | Wool | 20/30 | Wool |

Note!

- Agglomerating or ropy detergent or additive can be diluted in some water before pouring it into the detergent dispenser, to avoid its inlet to get blocked and thus cause a water overflow.
- Please choose the suitable type of detergent to get a maximum of washing performance and a minimum of water and energy consumption
- To achieve the best cleaning result a proper detergent dosing is important.
- Use a reduced detergent amount if the drum is not filled completely.
- Always adjust the amount of detergent to the water hardness, if your tap water is soft, use less detergent.
- Dose according to how dirty your laundry is, less dirty clothes require less detergent.
- Highly concentrated (compact detergent) requires particularly accurate dosing.

Following symptoms are a sign of detergent overdosing:

- heavy foam formation
- poor washing and rinsing result

Following symptoms are a sign of detergent underdosing:

- laundry turns grey
- built-up of limescale deposits on the drum, the heating element and/or the laundry

OPERATION

Control Panel

Model: PR147MD3INV PR148MD3INV

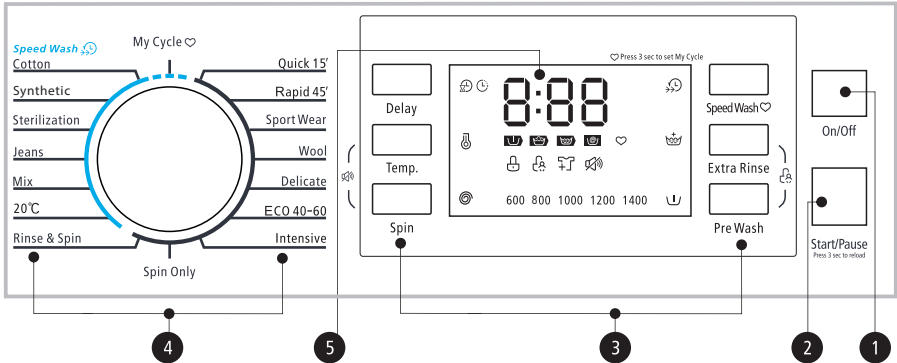

Note!

- The chart is for reference only, Please refer to real product as standard.

- Power**
Product is on/off.
- Start/Pause**
Press the button to start or pause the washing cycle.
- Option**
This allows you to select an additional function and will light when selected.
- Programmes**
Available according to the laundry type.
- Display**

The display shows the settings, estimated time remaining, options, and status messages for your washer. The display will remain on through the cycle.

| | | | |
|---|--|------------|-------------|
| A | Remain | G | Mute Buzzer |
| B | Delay | H | Reload |
| C | Speed Wash | I | Child Lock |
| D | My Cycle | J | Door Lock |
| E | Extra Rinse | K | Spin Speed |
| F | Pre Wash | L | Temp. |
| M | Rate Of Progress(Pre Wash- Wash -Rinse-Spin) | | |
| N | Wash Time | Delay Time | |
| | 1:25 | 2h | |
| | Error | End | |
| | E:20 | End | |

OPERATION

■ Programmes

Model: PR147MD3INV PR148MD3INV

| Programme | Load(kg) | | | Display Time |
|---------------|----------|-----|--|--------------|
| | 7.0 | 8.0 | | |
| | 7.0 | 8.0 | | 7.0/8.0 |
| Cotton | 7.0 | 8.0 | | 2:59 |
| Synthetic | 3.5 | 4.0 | | 2:45 |
| Sterilization | 3.5 | 4.0 | | 2:30 |
| Jeans | 7.0 | 8.0 | | 1:45 |
| Mix | 7.0 | 8.0 | | 0:58 |
| 20°C | 3.5 | 4.0 | | 1:01 |
| Rinse&Spin | 7.0 | 8.0 | | 0:20 |
| Spin Only | 7.0 | 8.0 | | 0:12 |
| Intensive | 7.0 | 8.0 | | 3:48 |
| ECO 40-60 | 7.0 | 8.0 | | 3:13/3:32 |
| Delicate | 2.0 | 2.0 | | 0:50 |
| Wool | 2.0 | 2.0 | | 1:07 |
| Sport Wear | 3.5 | 4.0 | | 0:45 |
| Rapid 45 | 2.0 | 2.0 | | 0:45 |
| Quick 15' | 2.0 | 2.0 | | 0:15 |



Note!

The parameters in this table are only for user's reference. The actual parameters maybe different with the parameters in above mentioned table

OPERATION

■ Programmes

| PR147MD3INV | | | | | | | |
|-------------|------------------------|---------------------|-------------------------------------|--|---|------------------------------|------------------------------------|
| Cycle | Nominal capacity in kg | Temperature setting | Cycle duration in hours and minutes | Energy consumption in kWh/operalling cycle | Water consumption in mliter//operalling cycle | Highest temperature ature °C | residual moitsure in % /spin speed |
| 20°C | 3.5 | 20 | 1:01 | 0.177 | 41 | 20 | 65%/1000 |
| Cotton | 7.0 | 60 | 3:14 | 1.340 | 65 | 60 | 53%/1400 |
| Intensive | 7.0 | 40 | 3:48 | 0.955 | 65 | 40 | 70%/800 |
| Mix | 7.0 | 40 | 0:58 | 0.657 | 65 | 40 | 70%/800 |
| Quick 15' | 2.0 | Cold | 0:15 | 0.030 | 31 | cold | 75%/800 |
| ECO40-60 | 7.0 | - | 3:28 | 0.775 | 54 | 36 | 53%/1400 |
| | 3.5 | - | 2:42 | 0.470 | 44 | 34 | 53%/1400 |
| | 2.0 | - | 2:42 | 0.200 | 35 | 21 | 53%/1400 |

- The above data is for reference only, and the data may change due to different actual use conditions.
- The valves given for programmes other than the ECO 40-60 programme are indicative only.
- Concerning to Regulation(EU) No 1061/2010,
The EU energy efficiency class is: A+++
Energy test program: Intensive 60/40 °C; Speed:The highest speed;
Other as the default.
Half load for 7.0Kg machine:3.5Kg.
- Concerning to Regulation(EU) 2019/2023,
The EU energy efficiency class is: B
Energy test program: ECO 40-60. Other as the default.
Half load for 7.0Kg machine:3.5Kg.
Quarter load for 7.0Kg machine:2.0Kg.

OPERATION

■ Programmes

| PR148MD3INV | | | | | | | |
|-------------|------------------------|---------------------|-------------------------------------|--|---|------------------------------|----------------------------------|
| Cycle | Nominal capacity in kg | Temperature setting | Cycle duration in hours and minutes | Energy consumption in kWh/operalling cycle | Water consumption in mliter//operalling cycle | Highest temperature ature °C | residual moisure in %/spin speed |
| 20°C | 4.0 | 20 | 1:01 | 0.183 | 44 | 20 | 65%/1000 |
| Cotton | 8.0 | 60 | 3:14 | 1.445 | 71 | 60 | 53%/1400 |
| Intensive | 8.0 | 40 | 3:48 | 1.013 | 71 | 40 | 70%/800 |
| Mix | 8.0 | 40 | 0:58 | 0.716 | 71 | 40 | 70%/800 |
| Quick 15' | 2.0 | Cold | 0:15 | 0.030 | 31 | cold | 75%/800 |
| ECO 40-60 | 8.0 | - | 3:38 | 0.857 | 59 | 34 | 53/1400 |
| | 4.0 | - | 2:48 | 0.504 | 46 | 29 | 53/1400 |
| | 2.0 | - | 2:48 | 0.24 | 37 | 21 | 53/1400 |

- The above data is for reference only, and the data may change due to different actual use conditions.
- The valves given for programmes other than the ECO 40-60 programme are indicative only.
- Concerning to Regulation(EU) No 1061/2010,
The EU energy efficiency class is: A+++
Energy test program: Intensive 60/40 °C; Speed:The highest speed;
Other as the default.
Half load for 8.0Kg machine:4.0Kg.
- Concerning to Regulation(EU) 2019/2023,
The EU energy efficiency class is: B
Energy test program: ECO 40-60. Other as the default.
Half load for 8.0Kg machine:4.0Kg.
Quarter load for 8.0Kg machine:2.0Kg.

OPERATION

- 1) The highest temperature reached by the laundry in the wash cycle for at least 5 minutes.
- 2) Residual moisture after the wash cycle in water content percent and the spin speed at which this was achieved.
- 3) The ECO 40-60 programme is able to clean normally soiled cotton laundry declared to be washable at 40°C or 60°C, together in the same cycle. This programme is used to assess the compliance with the regulation (EU) 2019/2023.

The most efficient programmes in terms of energy consumption are generally those that perform at lower temperatures and longer duration.

Loading the household washing machine up to the capacity indicated for the respective programmes will contribute to energy and water savings.

Noise and remaining moisture content are influenced by the spinning speed: the higher the spinning speed in the spinning phase, the higher the noise and the lower the remaining moisture content.

Caution!

- If there is any break in the power supply while the machine is operating, a special memory stores the selected programme. The machine will continue the programme when the power supply is re-established.

OPERATION





























■ Programmes

Programmes are available according to the laundry type.

| Programmes | |
|---------------|--|
| Cotton | Hard-wearing textiles, heat-resistant textiles made of cotton or linen. |
| Synthetic | Wash synthetic articles, for example: shirts, coats, blending. While washing the knitting textiles, detergent quantity shall be reduced due to its loose string construction and easily forming bubbles. |
| Sterilization | Keep the washing temperature above 60 degrees for more than 30 minutes, effectively remove harmful bacteria. |
| Jeans | Specially for jeans. |
| Mix | Mixed load consisting of textiles made of cotton and synthetics. |
| 20°C | 20°C default, can choose cold water. |
| Rinse&Spin | Extra rinse with spin. |
| Spin Only | Extra spin with selectable spin speed. |
| Intensive | To increase the washing effects, washing time is increased. |
| ECO 40-60 | This program is specially designed for washing duvet coats.. Default 40°C, not selectable, suitable for laundry washing at about 40°C-60°C. |
| Delicate | For delicate, washable textiles, e.g. made of silk, satin, synthetic fibres or blended fabrics. |
| Wool | Hand or machine-washable wool or richwool textiles. Especially gentle wash programme to prevent shrinkage, longer programme pauses (textiles rest in wash liquor). |
| Sport Wear | Washing the activewear. |
| Rapid 45' | This programme is suitable for washing not very dirty clothes, save more energy and washing. |
| Quick 15' | Extra short programme approx, suitable for lightly soiled washing as a small amounts of laundry. |

OPERATION

■ Option

| Cycle | Default Temp.(°C) | Default spin speed in rpm | | Additional functions |
|---------------|-------------------|---------------------------|--|---|
| Wash cycles | | 1400 | | |
| Quick 15' | Cold | 800 | | Delay,  |
| Rapid 45' | 40 | 800 | | Delay,  ,  |
| SportWear | 20 | 800 | | Delay,  ,  |
| Wool | 40 | 600 | | Delay,  |
| Delicate | 30 | 600 | | Delay,  |
| ECO 40-60 | -- | 1400 | | Delay,  |
| Intensive | 40 | 800 | | Delay,  |
| Spin Only | -- | 1000 | | Delay,  |
| Rinse & Spin | -- | 1000 | | Delay,  |
| 20°C | 20 | 1000 | | Delay,  ,  |
| Mix | 40 | 800 | | Delay,  ,  ,  |
| Jeans | 60 | 800 | | Delay,  ,  ,  |
| Sterilization | -- | 800 | | Delay,  ,  ,  |
| Synthetic | 40 | 1200 | | Delay,  ,  ,  |
| Cotton | 40 | 1400 | | Delay,  ,  ,  |

Note!

- For the maximum spin speed, program time, and other details of the ECO 40-60 program, please refer to the content on the Product Fiche page.
- The table shows which cycle offers which options for adjustment. If an adjustment is not possible for a cycle.

OPERATION

Delay

Delay

Set the Delay function:

1. Select a programme;
2. Press the Delay button to choose the time (the delaying time is 0-24 H.);
3. Press [Start/Pause] to commence the delay operation



Choose the Programme

Setting time

Start

Cancel the Delay function:

Press the [Delay] button until the display be 0H. It should be pressed before starting the programme. If the programme already started, should switch off programme to reset a new one.

⚠ Caution!

- If there is any break in the power supply while the machine is operating, a special memory stores the selected programme and when the power is restarted, the program will continue.

Pre Wash

Pre Wash

The Prewash function can get an extra wash before main wash, it is suitable for washing the dust rises to surface of the clothes; You need to put detergent into the Case (I) when select it.

Extra Rinse

Extra Rinse

The laundry will undergo extra rinse once after you select it.

Speed Wash

Speed Wash

The function can decrease the washing time.



My Cycle

To memory the frequently used programme.

After choosing the programme and setting the options, press [Speed Wash ♡] 3 sec. before start to wash. The default setting course is Cotton.

OPERATION



Reload

This operation can be executed during the washing progress. When the drum is still rolling and there is large amount of water with high temperature in the drum. The state is unsafe and the door cannot be opened forcefully. To press [Start/Pause] for 3 sec. to reload, and start the clothes adding in the midway function. Please follow the steps as bellow:

- 1.Wait until the drum stops rotation.
- 2.The door lock is unlocked.
- 3.Close the door when the clothes are reloaded and press the [Start/Pause] button.



Press[Start/Pause]3sec.



Reload the clothes



Start

! Caution!

- Don't use the Reload function when the water level over the edge of the inner tub or the temperature is higher.

Temp.

Temp.

Press the button to regulate the temperature(Cold,20°C,30°C, 40°C,60°C,90°C)

Spin

Spin

Press the button to change the speed.

1400: 0-600-800-1000-1200-1400

OPERATION



Child Lock

To avoid mis operation by children.



Press [Extra Rinse] and [Pre Wash]
3 sec. till buzzer beep.

⚠ Caution!

When child lock is activated and program starts, child lock indicator will switch on, and the CL and remaining time on the display are alternately displayed in 0.5s.

Press the other buttons will make child lock indicator flash for 3s. when program finish, CL and END alternate for 10s in 0.5s, then the child lock lights flash for 3s

- Only press and hold the two button can release child lock, even power off, switch off and program end
- The "Child Lock" will lock all buttons except Power button and Child Lock button
- Please release child lock before selecting program and starting washing



Mute the buzzer



Choose the Programme

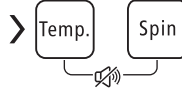

Press the [Temp.]and[Spin] for 3sec.,
the buzzer is mute.

To act the buzzer function, press the button again for 3 seconds. The setting will be kept until the next reset.

⚠ Caution!

- After Muting the buzzer function, the sounds will not be activated any more.

MAINTENANCE

■ Cleaning and Care

⚠ Warning!

- Always unplug the appliance and close the water tap before cleaning and maintenance.

Cleaning the Cabinet

Proper maintenance on the washing machine can extend its working life. The surface can be cleaned with diluted non-abrasive neutral detergents when necessary. If there is any water overflow, use a cloth to wipe it off immediately. Never use sharp items to clean the appliance.

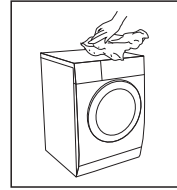

⚠ Caution!

- Never use abrasive or caustic agents, formic acids or its diluted solvents or similar substances, like alcohol or chemical products.

Cleaning the Drum

Any rust stains left inside the drum by metal articles must be removed immediately using chlorine-free detergents. Never use steel wool for cleaning the drum!

📌 Note!

- Keep any laundry away from the machine while cleaning the drum.

Cleaning the Door Seal and Glass

Wipe the glass and seal after each wash to remove lint and stains. If lint builds up it can cause leakages.

Remove any coins, buttons and other objects from the seal after each wash.

Clean the Door Seal and Glass every month to ensure the normal operation of the appliance.

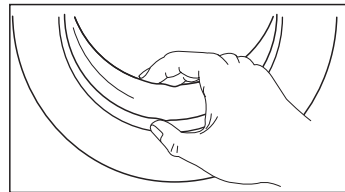

MAINTENANCE

Cleaning the Inlet Filter

Note!

- Diminishing water flow is a sign that the filter need to be cleaned.

1. Close the tap and remove the water supply hose from it.
2. Clean the filter with a brush.
3. Unscrew the water supply hose from the backside of the machine. Pull out the filter with long nose pliers.
4. Use a brush to clean the filter.
5. Reinstall the filter to the water inlet and reconnect the water supply hose.
6. Clean the Inlet filter every 3 months to ensure the normal operation of the appliance.

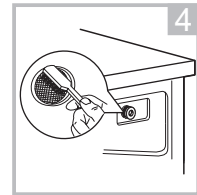
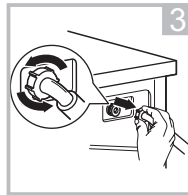
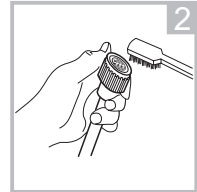
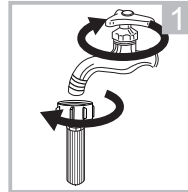

Clean The Detergent Dispenser

1. Press down the release [] on the softener cover and pull the dispenser drawer out of the recess. Clean the inside of the recess with a brush.
2. Lift the softener cover off the dispenser drawer and wash both items with water.
3. Restore the softener cover and push the drawer back into the recess.

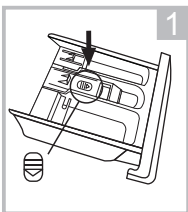

Press the release and remove the dispenser drawer

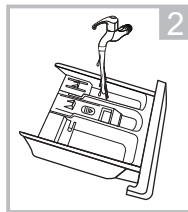

Clean the dispenser drawer and the softener cover under water

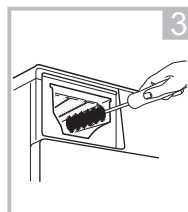

Clean the recess with an soft brush

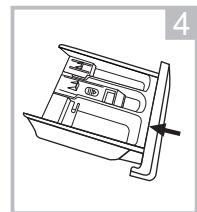

Insert the dispenser drawer

Note!

- Do not use abrasive or caustic agents to clean plastic parts.
- Clean the detergent dispenser every 3 months to ensure the normal operation of the appliance.

MAINTENANCE

Cleaning the Drain Pump Filter

⚠ Warning!

- Make sure that the machine has finished the washing cycle and is empty. Switch it off and unplug it before cleaning the drain pump filter.
- Be careful of hot water. Allow the water to cool down. Risk of scalding!
- Clean the filter periodically every 3 months to ensure the normal operation of the appliance.

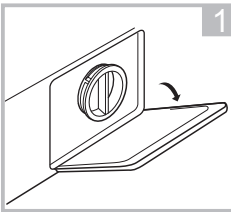

Open the lower cover cap

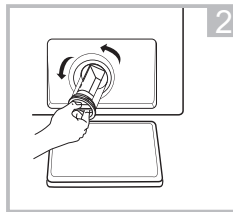

Open the filter by turning to the counter clockwise

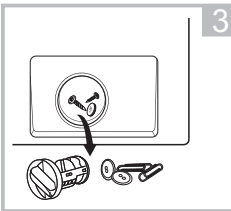

Remove extraneous matter

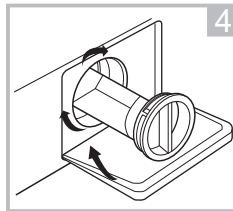

Close the lower cover cap

⚠ Caution!

- Make sure emergency drain hose cap and the emergency drain hose are reinstalled properly, otherwise water may leak.

MAINTENANCE

■ Trouble Shooting

Whenever there is a problem with the appliance, check if you can solve it following the tables below. If the problem persists, please contact the customer service.

| Description | Possible cause | Solution |
|---|--|---|
| Appliance does not start | Door is not closed properly. Clothes are stuck. | Close the door properly and restart. Check the laundry. |
| Door can't be opened | Safety protection is activated. | Disconnect the power and restart. |
| Water leakage | Connections are not tight enough. | Check and fasten the water inlet pipe. Check and clean the outlet hose. |
| Detergent residues in the detergent dispenser | Detergent is damp and/or clotted. | Clean and wipe the detergent dispenser dry. |
| Indicator or display does not work | PC board or harness have connection problems. | Switch off the power and check if the mains plug is connected properly. |
| Abnormal noise | Fixing bolts still in place. Floor is not solid or level. | Check if the fixing bolts have been removed Make sure the appliance is installed on a solid and level floor. |

Error Codes

| Description | Possible cause | Solution |
|-------------|--|--|
| E30 | Door is not closed properly | Close the door properly and restart. |
| E10 | Water injecting problem during wash cycle. | Check if the water pressure is high enough. Straighten the water pipe. Clean the inlet valve filter. |
| E21 | Overtime water draining | Check the drain hose for blockage. |
| E12 | Water overflow | Restart the appliance. |
| EXX | Others | Restart the appliance. If problem persists, please contact the customer service. |

MAINTENANCE

■ Customer service

Spare part for your appliance are available for a minimum of 10 years.

In case of questions please contact our customer service at:

⚠ Warning!

Risk of electric shock

- Never try repair an appliance which is defective or presumed to be defective. You may put your own and future users' lives in danger. Only authorised specialists are allowed to carry out this repair work.
- Improper repair will void the warranty and subsequent damages can't be recognized!

Transport

IMPORTANT STEPS WHEN MOVING THE APPLIANCE

- Unplug the appliance and close the water inlet tap.
- Check, if the door and the detergent dispenser are closed properly.
- Remove the water inlet pipe and the outlet hose from the house installations.
- Let the water drain completely from the appliance (see "Maintenance Cleaning the drain pump filter")
- Important: Re-install the 4 transport bolts in the back of the appliance.
- This appliance is heavy. Transport with care. Never hold any protruding part of the machine when lifting. The machine door cannot be used as a handle.

■ Technical Specifications

Power Supply 220-240V~,50Hz

MAX.Current 10A

Standard Water Pressure 0.05MPa~1MPa

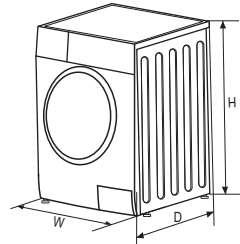

| Model | Washing Capacity | Dimension (W*D*Hmm) | Net Weight | Rated Power |
|-------------|------------------|---------------------|------------|-------------|
| PR147MD3INV | 7.0kg | 595*495*850 | 60kg | 2000W |
| PR148MD3INV | 8.0kg | 595*565*850 | 68kg | 2000W |
| | | | | |

MAINTENANCE

■ Product Fiche

Product fiche concerning to EN 60456:2016 With (EU)No.1061/2010.

| | |
|---|-------------|
| Trade mark | |
| Model identifier | PR147MD3INV |
| Rated capacity in kg of cotton laundry | 7 |
| Energy efficiency class on a scale from A+++ (most efficient) bis D (least efficient) | A+++ |
| Energy consumptior 155 kWh per year, based on 220 standard washing cycles for the standard programmes at 60 °C and 40 °C at full and partial load, and the consumption of the low-power modes. Actual energy consumption will depend on how the appliance is used. | |
| Energy consumption of the standard 60°C programme at full load | 0.75kwh |
| Energy consumption of the Intensive 60°C programme at partial load | 0.70kwh |
| Energy consumption of the Intensive 40°C programme at partial load | 0.57kwh |
| Weighted power consumption of the off-mode | 0.50W |
| Weighted power consumption of the left-on mode | 1.00W |
| Water consumption 9900 litres per year, based on 220 standard washing cycles for Intensive programmes at 60 °C and 40 °C at full and partial load. Actual water consumption will depend on how the appliance is used. | |
| spin-drying efficiency class B on a scale from G (least efficient) to A (most efficient) | |
| maximum spin speed | 1400 |
| Remaining moisture content | 53% |
| 'Intensive 60°C programme' and the ' Intensive 40°C programme' are the standard washing programmes to which the information in the label and the fiche relates, that these programmes are suitable to clean normally soiled cotton laundry and that they are the most efficient programmes in terms of combined energy and water consumption. | |
| Programme time of Intensive 60°C programme at full load | 280min |
| Programme time of Intensive 60°C programme at half load | 270min |
| Programme time of Intensive 40°C programme at half load | 270min |
| duration time of left-on mode | - |
| Airborne acoustical noise emissions during washing phase | 57dB |
| Airborne acoustical noise emissions during spinning phase | 79dB |
| 'built-in' washing machine | no |

Energy test program: Intensive 60/40 Speed: the highest speed; Other as the default.

MAINTENANCE

Product Information Sheet acc. regulation (EU) 2019/2023

Supplier's name or trade mark:

Supplier's address ^(b):

Model identifier: PR147MD3INV

General product parameters:

| Parameter | Value | | Parameter | Value | |
|--|----------------|-------|---|----------------|----|
| Rated capacity ^(a) (kg) | 7.0 | | Dimensions in cm | Height | 85 |
| | | | | Width | 60 |
| | | | | Depth | 50 |
| EEL _w ^(a) | 59.9 | | Energy efficiency class ^(a) | B | |
| Washing efficiency index ^(a) | 1.04 | | Rinsing effectiveness (g/kg) ^(a) | 5.0 | |
| Energy consumption in kWh per cycle, based on the eco 40-60 programme. Actual energy consumption will depend on how the appliance is used. | 0.516 | | Water consumption in litre per cycle, based on the eco 40-60 programme. Actual water consumption will depend on how the appliance is used and on the hardness of the water. | 45 | |
| Maximum temperature inside the treated textile ^(a) (°C) | Rated capacity | 36 | Remaining moisture content ^(a) (%) | Rated capacity | 53 |
| | Half | 34 | | Half | 53 |
| | Quarter | 21 | | Quarter | 53 |
| Spin speed ^(a) (rpm) | Rated capacity | 1400 | Spin-drying efficiency class ^(a) | B | |
| | Half | 1400 | | | |
| | Quarter | 1400 | | | |
| Programme duration ^(a) (h:min) | Rated capacity | 3: 28 | Type | free-standing | |
| | Half | 2: 42 | | | |
| | Quarter | 2: 42 | | | |
| Airborne acoustical noise emissions in the spinning phase ^(a) (dB(A) re 1 pW) | 76 | | Airborne acoustical noise emission class ^(a) (spinning phase) | B | |
| Off-mode (W) | 0.50 | | Standby mode (W) | N/A | |
| Delay start (W) (if applicable) | 4.00 | | Networked standby (W) (if applicable) | N/A | |

Minimum duration of the guarantee offered by the supplier ^(b):

| | |
|--|----|
| This product has been designed to release silver ions during the washing cycle | NO |
|--|----|

Additional information:

Weblink to the supplier's website, where the information in point 9 of Annex II to Commission Regulation (EU) 2019/2023 (1) (b) is found:

^(a) for the eco 40-60 programme.

^(b) changes to these items shall not be considered relevant for the purposes of paragraph 4 of Article 4 of Regulation (EU) 2017/1369.

^(c) if the product database automatically generates the definitive content of this cell the supplier shall not enter these data.

MAINTENANCE

Product fiche concerning to EN 60456:2016 With (EU)No.1061/2010.

| | |
|--|-------------|
| Trade mark | |
| Model identifier | PR148MD3INV |
| Rated capacity in kg of cotton laundry | 8 |
| Energy efficiency class on a scale from A+++ (most efficient) bis D (least efficient) | A+++ |
| Energy consumption 175 kWh per year, based on 220 standard washing cycles for Intensive programmes at 60 °C and 40 °C at full and partial load, and the consumption of the low-power modes. Actual energy consumption will depend on how the appliance is used. | |
| Energy consumption of the Intensive 60°C programme at full load | 0.82kwh |
| Energy consumption of the Intensive 60°C programme at partial load | 0.75kwh |
| Energy consumption of the Intensive 40°C programme at partial load | 0.73kwh |
| Weighted power consumption of the off-mode | 0.50W |
| Weighted power consumption of the left-on mode | 1.00W |
| Water consumption 11000 litres per year, based on 220 standard washing cycles for Intensive programmes at 60 °C and 40 °C at full and partial load. Actual water consumption will depend on how the appliance is used. | |
| spin-drying efficiency class B on a scale from G (least efficient) to A (most efficient) | |
| maximum spin speed | 1400 |
| Remaining moisture content | 53% |
| 'Intensive 60°C programme' and the 'Intensive 40°C programme' are the standard washing programmes to which the information in the label and the fiche relates, that these programmes are suitable to clean normally soiled cotton laundry and that they are the most efficient programmes in terms of combined energy and water consumption. | |
| Programme time of Intensive 60°C programme at full load | 280min |
| Programme time of Intensive 60°C programme at half load | 270min |
| Programme time of Intensive 40°C programme at half load | 270min |
| duration time of left-on mode | - |
| Airborne acoustical noise emissions during washing phase | 57dB |
| Airborne acoustical noise emissions during spinning phase | 79dB |
| 'built-in' washing machine | no |

Energy test program: Intensive 60/40 °C; Speed: the highest speed; Other as the default.

MAINTENANCE

Product Information Sheet acc. regulation (EU) 2019/2023

Supplier's name or trade mark:

Supplier's address ^(b):

Model identifier: PR148MD3INV

General product parameters:

| Parameter | Value | | Parameter | Value | |
|--|----------------|--------|---|----------------|----|
| Rated capacity ^(a) (kg) | 8.0 | | Dimensions in cm | Height | 85 |
| | | | | Width | 60 |
| | | | | Depth | 57 |
| EEL _w ^(a) | 60.0 | | Energy efficiency class ^(a) | B | |
| Washing efficiency index ^(a) | 1.04 | | Rinsing effectiveness (g/kg) ^(a) | 5.0 | |
| Energy consumption in kWh per cycle, based on the eco 40-60 programme. Actual energy consumption will depend on how the appliance is used. | 0.545 | | Water consumption in litre per cycle, based on the eco 40-60 programme. Actual water consumption will depend on how the appliance is used and on the hardness of the water. | 48 | |
| Maximum temperature inside the treated textile ^(a) (°C) | Rated capacity | 34 | Remaining moisture content ^(a) (%) | Rated capacity | 53 |
| | Half | 29 | | Half | 53 |
| | Quarter | 21 | | Quarter | 53 |
| Spin speed ^(a) (rpm) | Rated capacity | 1400 | Spin-drying efficiency class ^(a) | B | |
| | Half | 1400 | | | |
| | Quarter | 1400 | | | |
| Programme duration ^(a) (h:min) | Rated capacity | 3 : 38 | Type | free-standing | |
| | Half | 2 : 48 | | | |
| | Quarter | 2 : 48 | | | |
| Airborne acoustical noise emissions in the spinning phase ^(a) (dB(A) re 1 pW) | 76 | | Airborne acoustical noise emission class ^(a) (spinning phase) | B | |
| Off-mode (W) | 0.50 | | Standby mode (W) | N/A | |
| Delay start (W) (if applicable) | 4.00 | | Networked standby (W) (if applicable) | N/A | |

Minimum duration of the guarantee offered by the supplier ^(b):

This product has been designed to release silver ions during the washing cycle

NO

Additional information:

Weblink to the supplier's website, where the information in point 9 of Annex II to Commission Regulation (EU) 2019/2023 (1) (b) is found:

^(a) for the eco 40-60 programme.

^(b) changes to these items shall not be considered relevant for the purposes of paragraph 4 of Article 4 of Regulation (EU) 2017/1369.

^(c) if the product database automatically generates the definitive content of this cell the supplier shall not enter these data.

MAINTENANCE

- 1) The actual energy consumption will depend on how the appliance is used.
- 2) The actual water consumption will depend on how the appliance is used and on the hardness of the water.
- 3) Delivery of the spare parts within 15 working days after having received the order.

Product Data Sheet concerning (EU) 2019/2014

The product data sheet for your appliance can be found online.

Go to <https://eprel.ec.europa.eu> and enter the model identifier for your appliance to download the data sheet.

The model identifier for your appliance can be found in the technical specifications section.



KONČAR - KUĆANSKI APARATI d.d.

Slavonska avenija 16 , 10001 Zagreb , Hrvatska

tel : ++ 385 1/2484 555

fax : ++ 385 1/2404 102

www.koncar-ka.hr